

080120	紅皮症				080120xxxxxxxx
080130	角化症、角皮症				080130xxxxxxxx
080140	炎症性角化症				080140xxxxxxx
080150	爪の疾患	手術	なし		080150xx99xxxx
			あり		080150xx97xxxx
080160	皮膚の萎縮性障害				080160xxxxxxxx
080180	母斑、母斑症	手術	なし		080180xx99xxxx
			あり	手術・処置等1	
				なし	080180xx970xxx
				あり	080180xx971xxx
080190	脱毛症				080190xxxxxxxx
080210	ざ瘡、皮膚の障害（その他）				080210xxxxxxxx

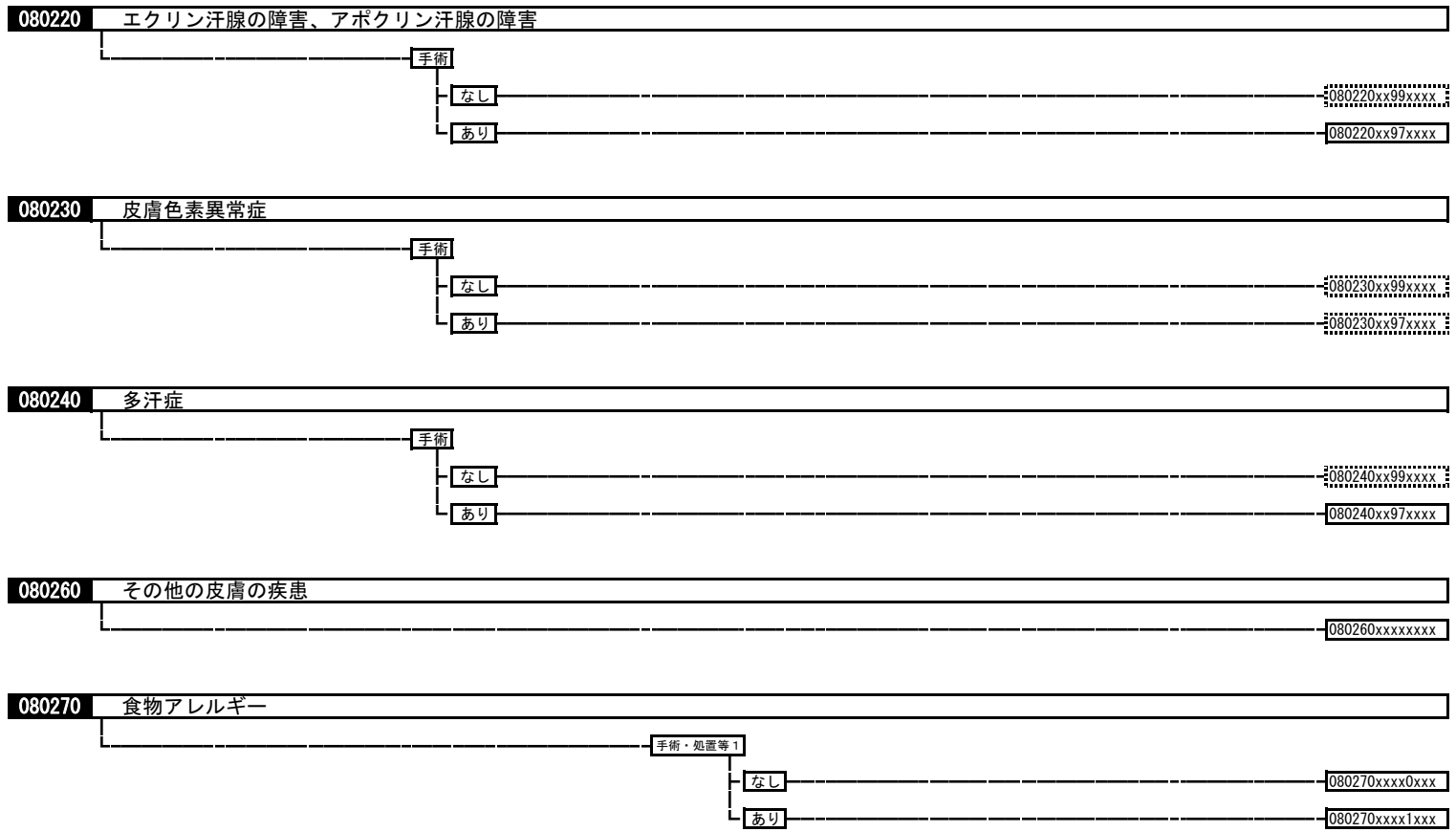

090010 乳房の悪性腫瘍

手術・処置等2
 1: 人工呼吸など
 2: 放射線療法
 3: 化学療法あり、放射線療法なし
 4: シクロホスファミド+塩酸エビルピシンあり、
 パクリタキセル又はドセタキセルあり
 5: トラスツスマブ

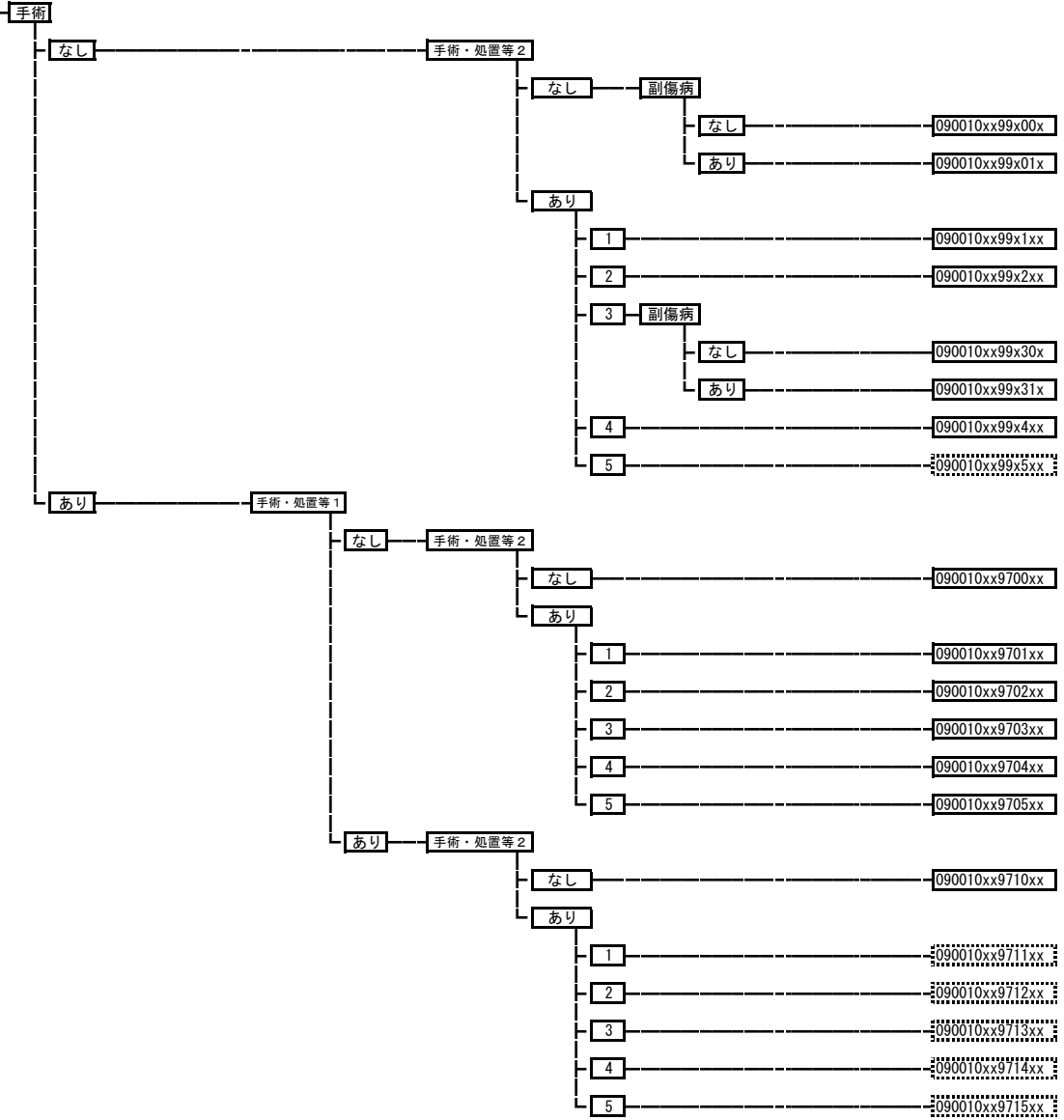

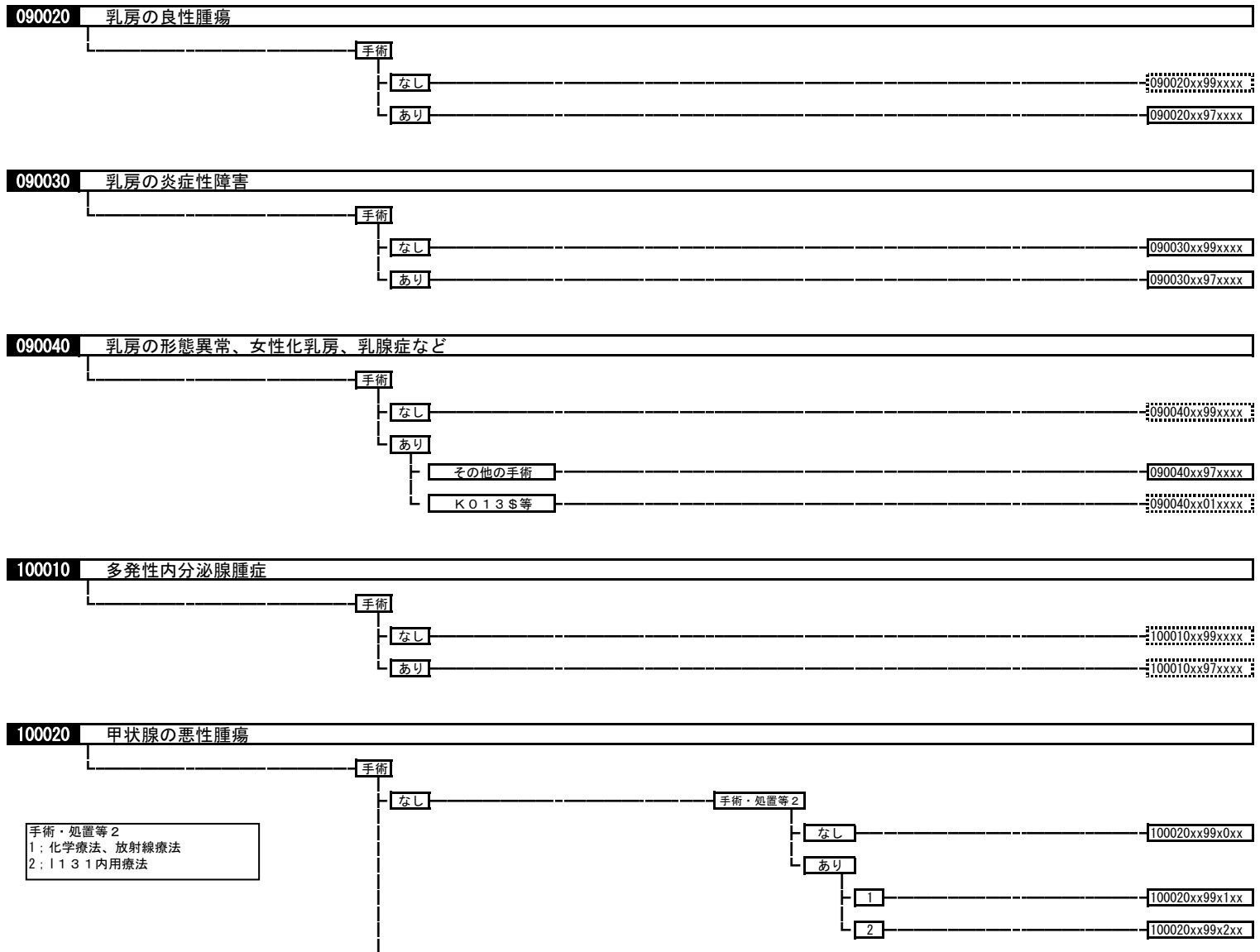

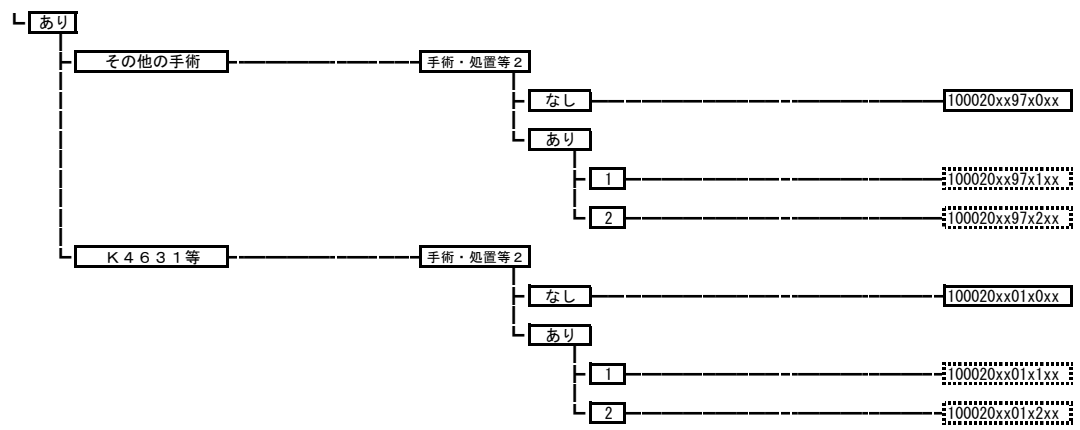

100030 内分泌腺および関連組織の腫瘍

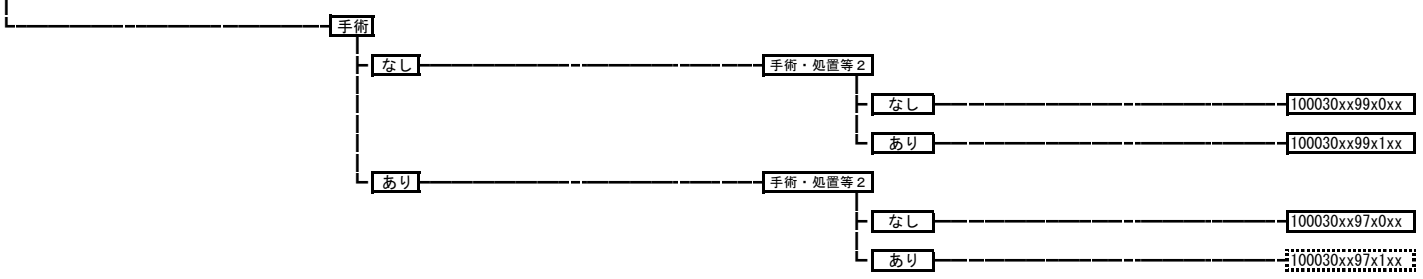

100040 糖尿病性ケトアシドーシス、非ケトン昏睡

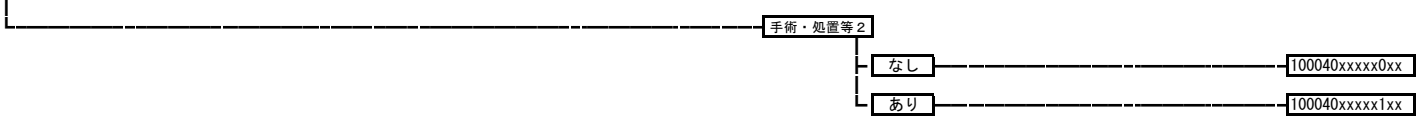

100050 低血糖症（糖尿病治療に伴う場合）

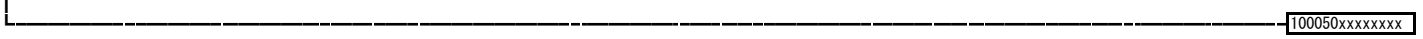

100060 1型糖尿病（糖尿病性ケトアシドーシスを除く。）

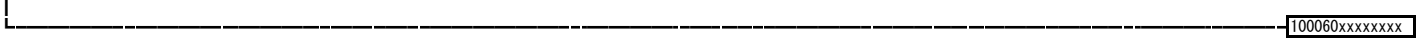

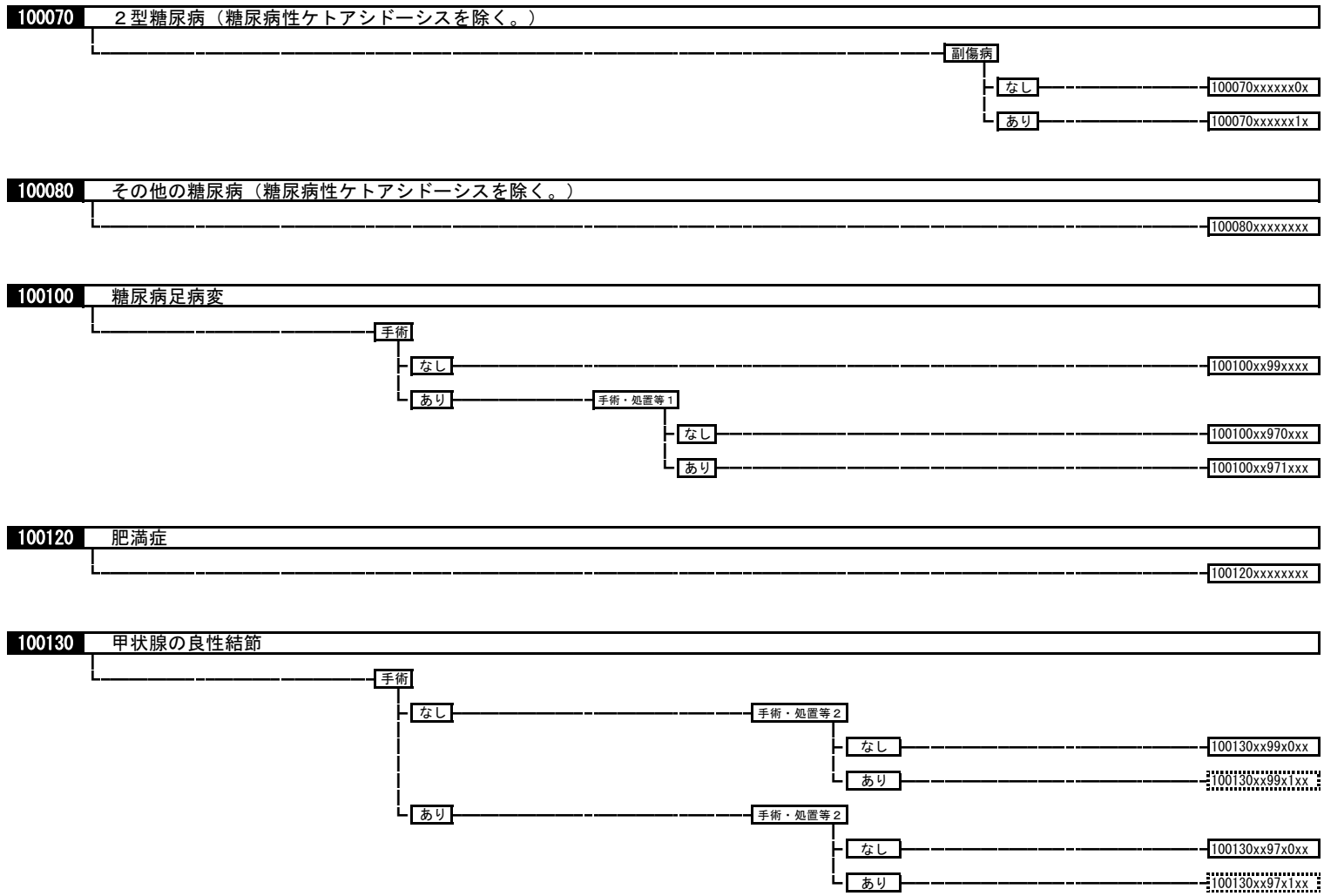



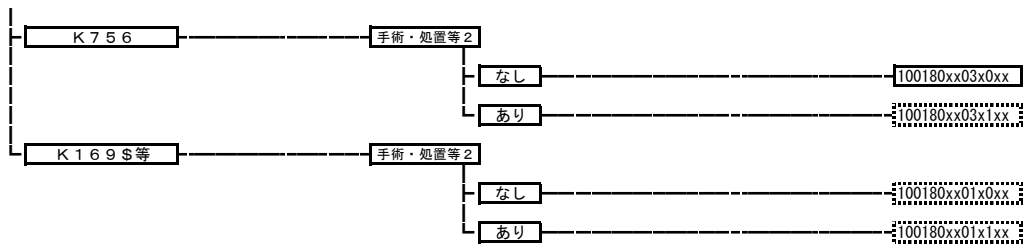

100190 褐色細胞腫、パラガングリオーマ

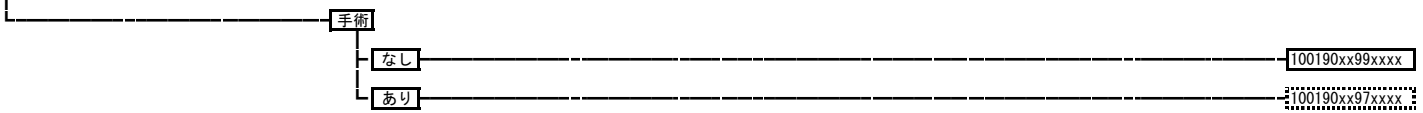

100202 その他の副腎皮質機能低下症

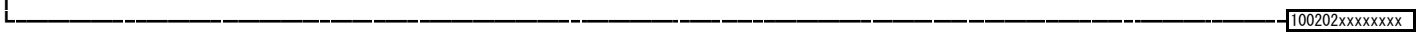

100210 低血糖症

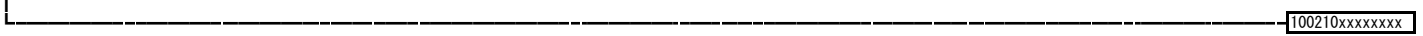

100220 原発性副甲状腺機能亢進症、副甲状腺腫瘍

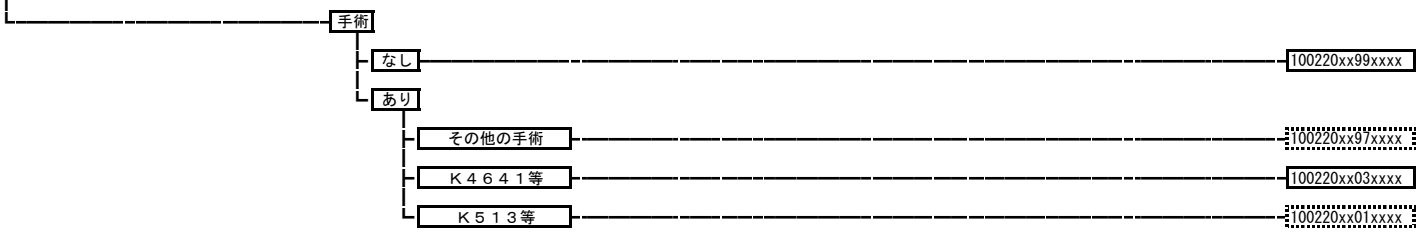

100230 続発性副甲状腺機能亢進症

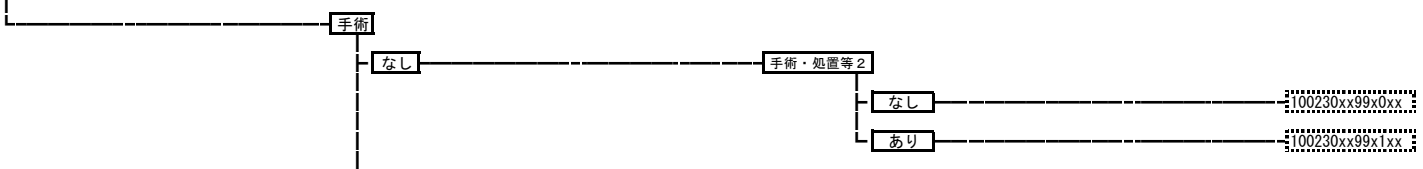

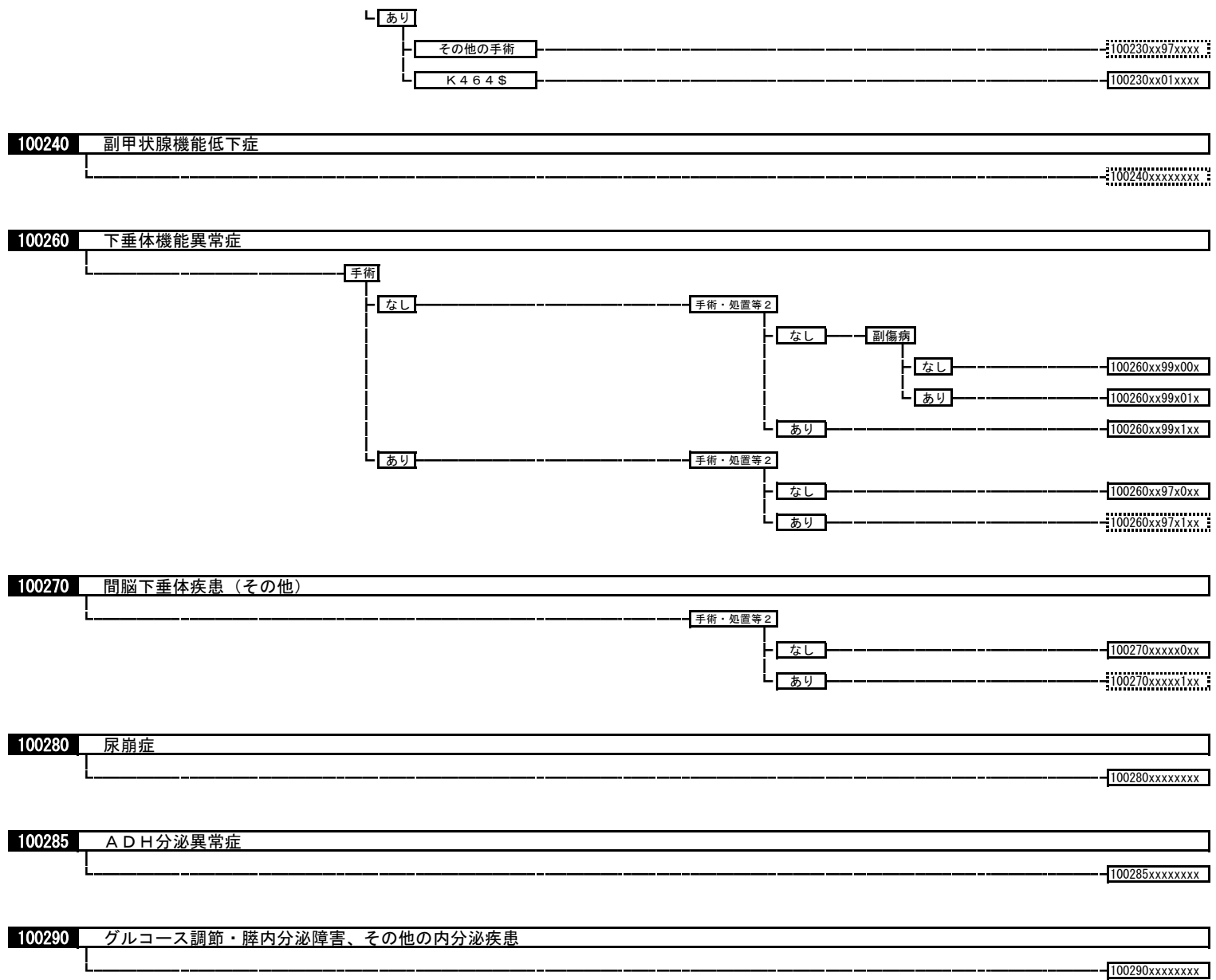

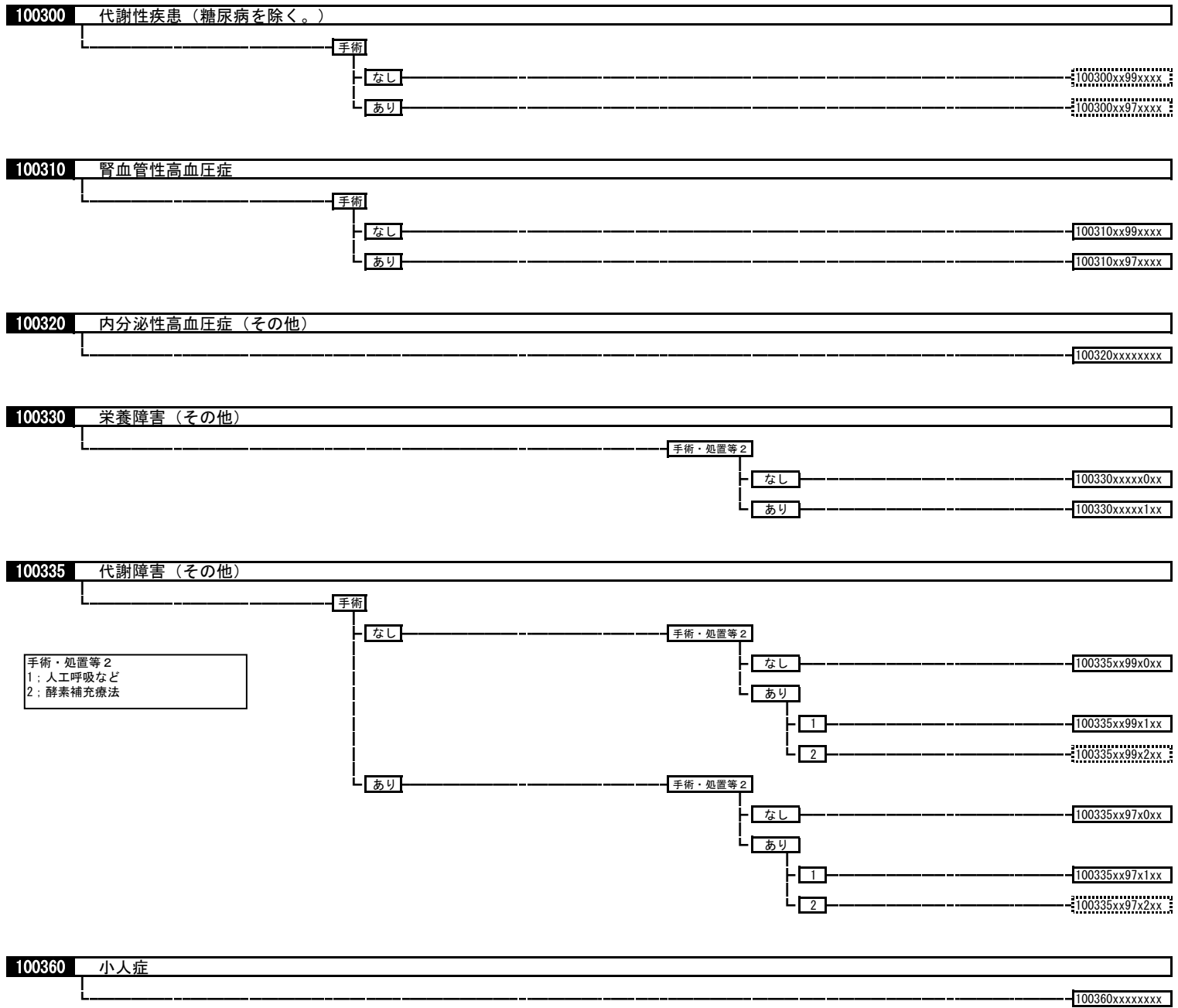

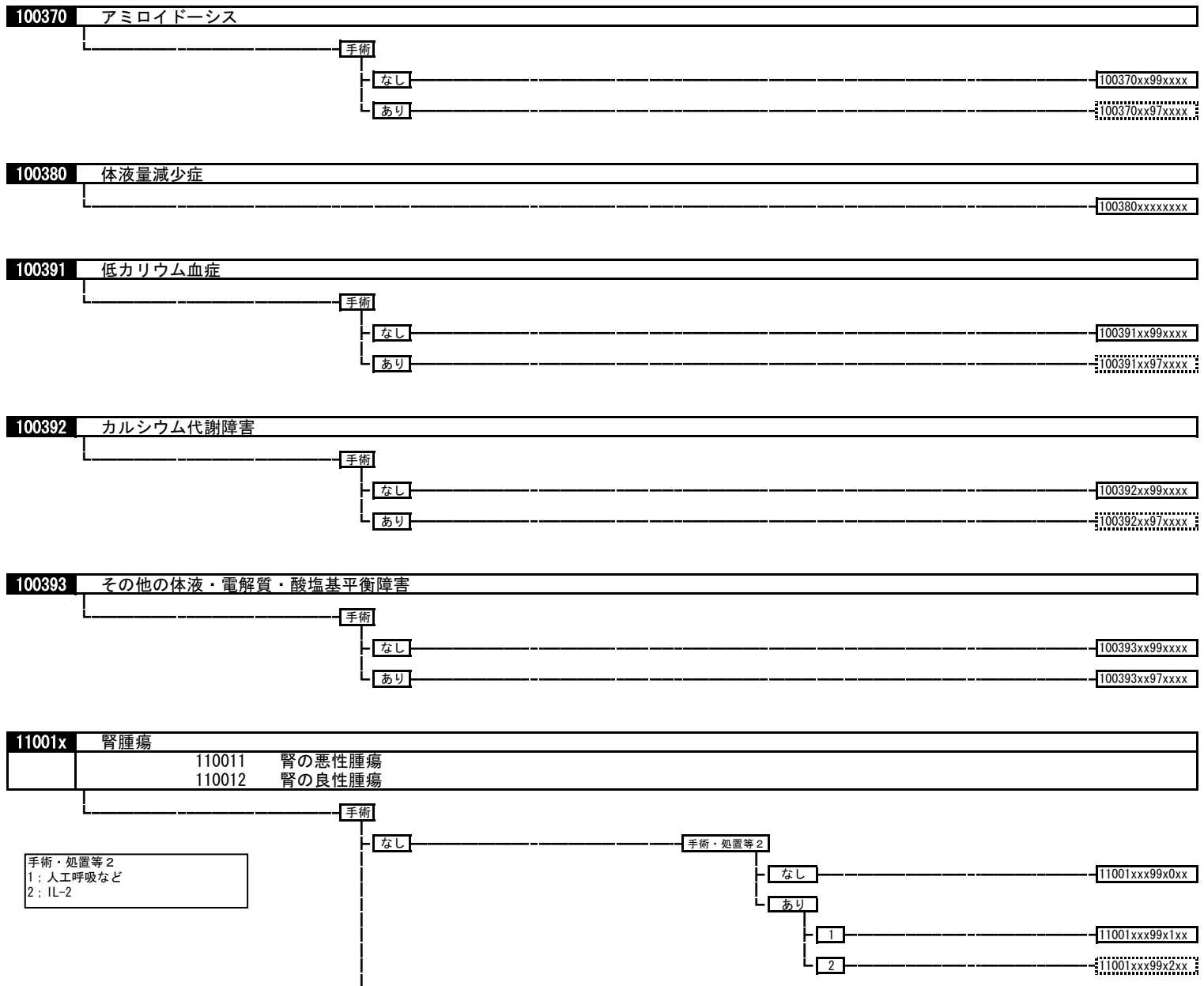

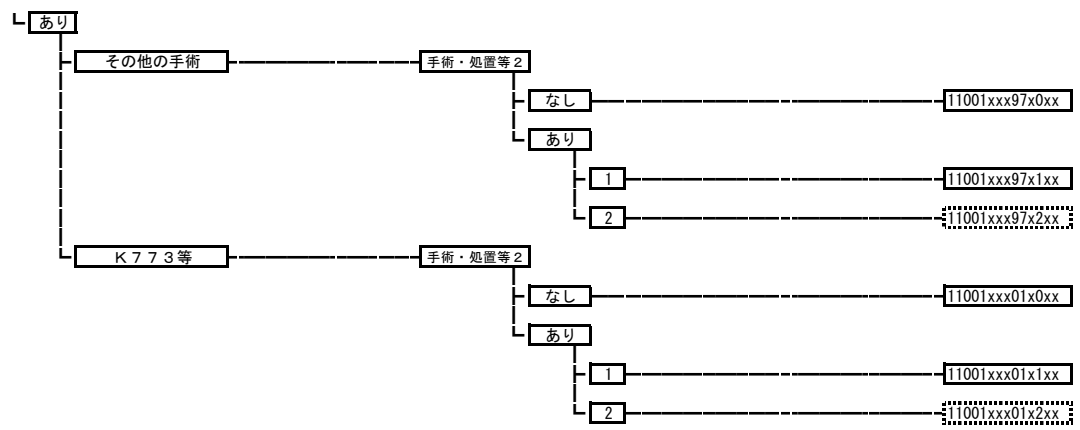

11002x	性器の悪性腫瘍	
	110021	陰茎の悪性腫瘍
	110022	性器の悪性腫瘍

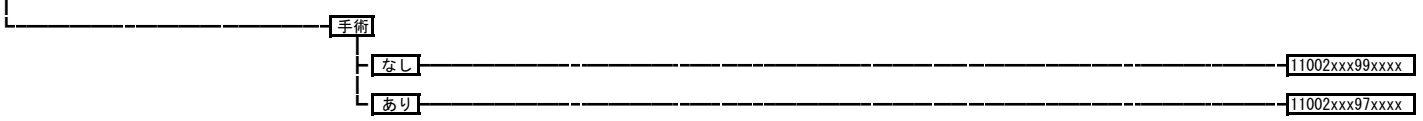

11004x	尿道・性器の良性腫瘍	
	110041	尿道腫瘍
	110042	性器の良性腫瘍（その他）

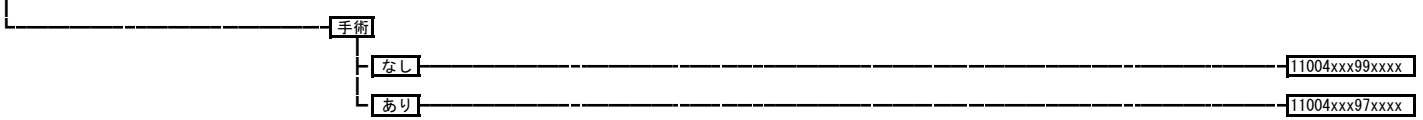

110050	後腹膜疾患	
---------------	-------	--

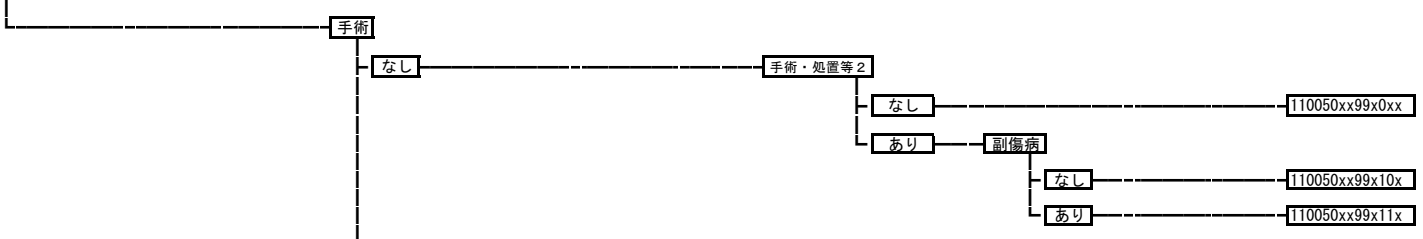

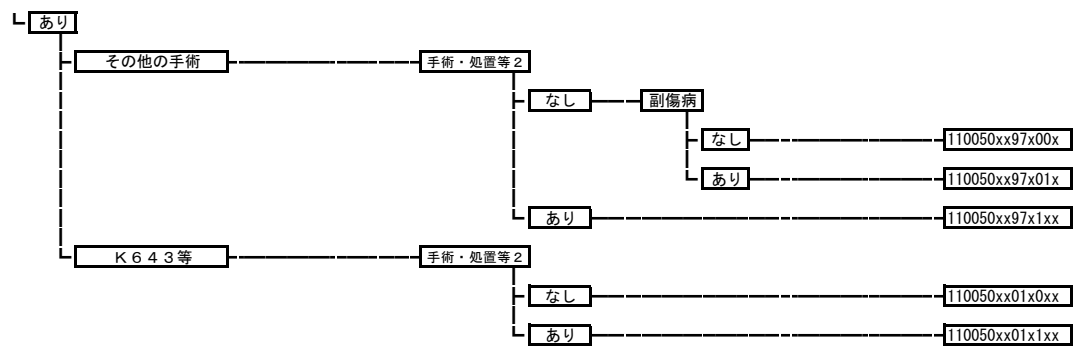

110060 腎盂・尿管の悪性腫瘍

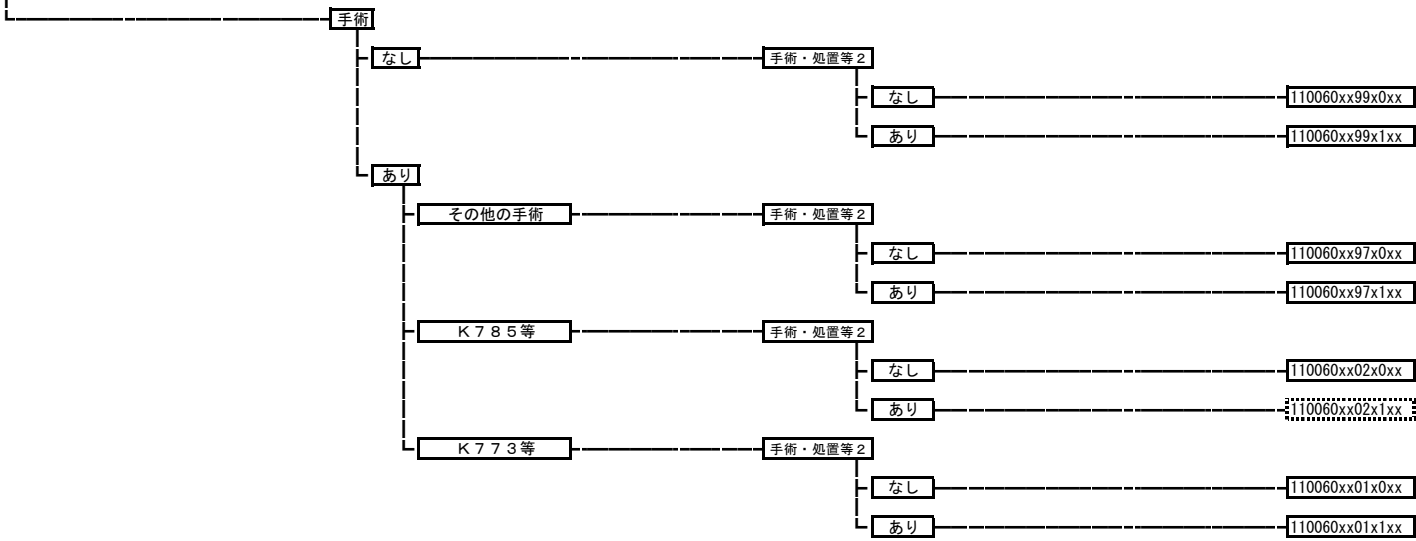

110070 膀胱腫瘍

