

78

午 前

別 冊







No. 1

(問題4)

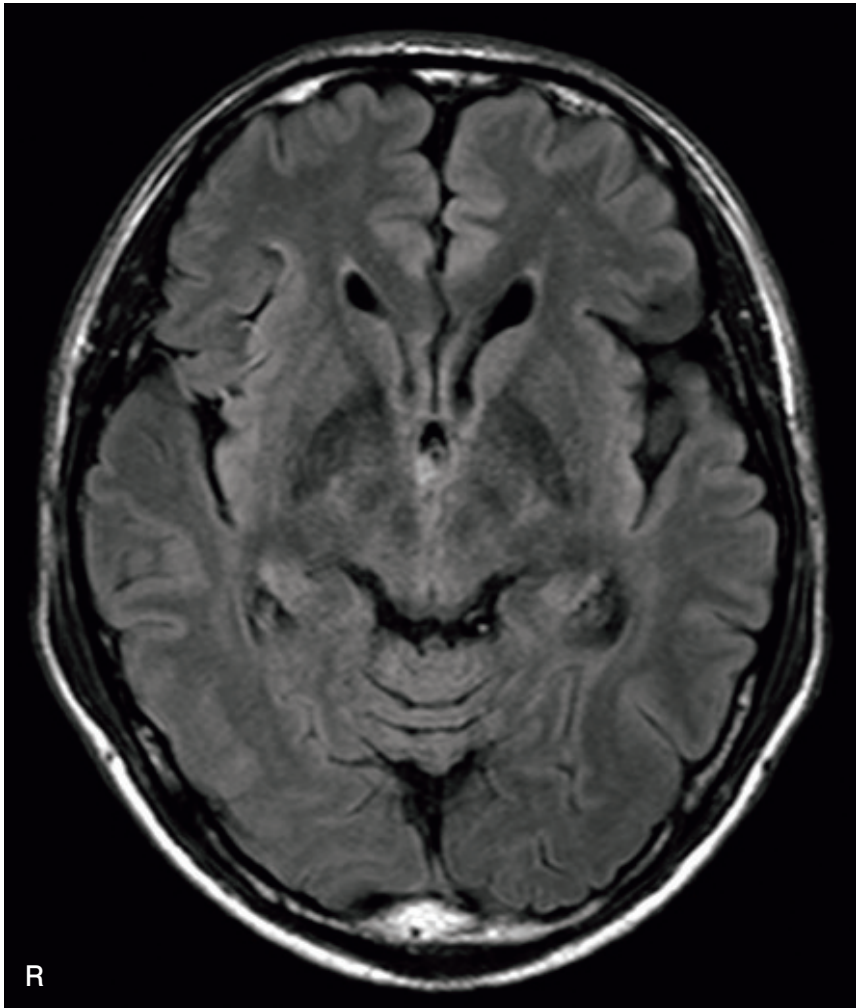

No. 2

(問題6)

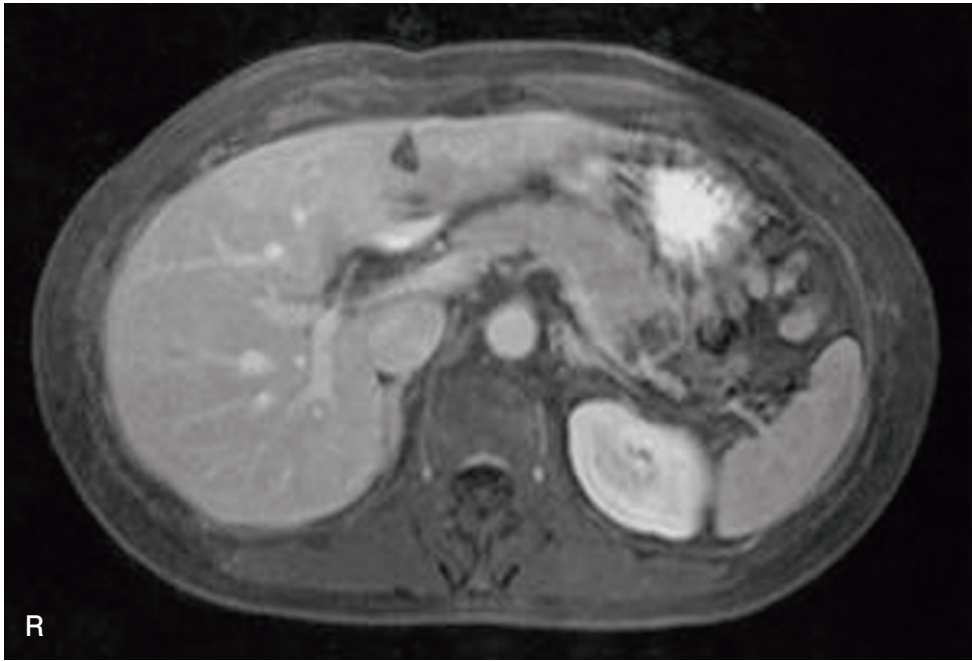

No. 3

(問題7)



No. 4

(問題9)

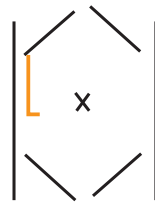
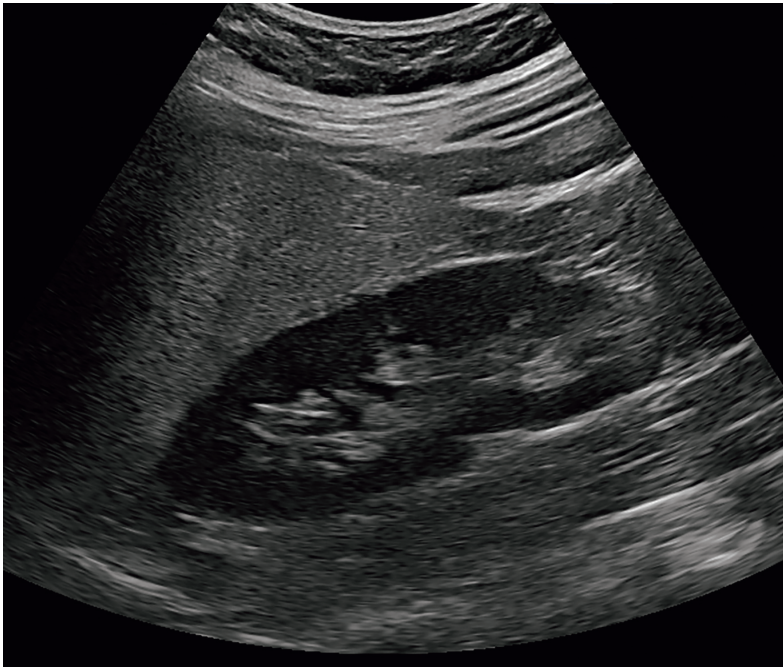

No. 5

(問題 10)

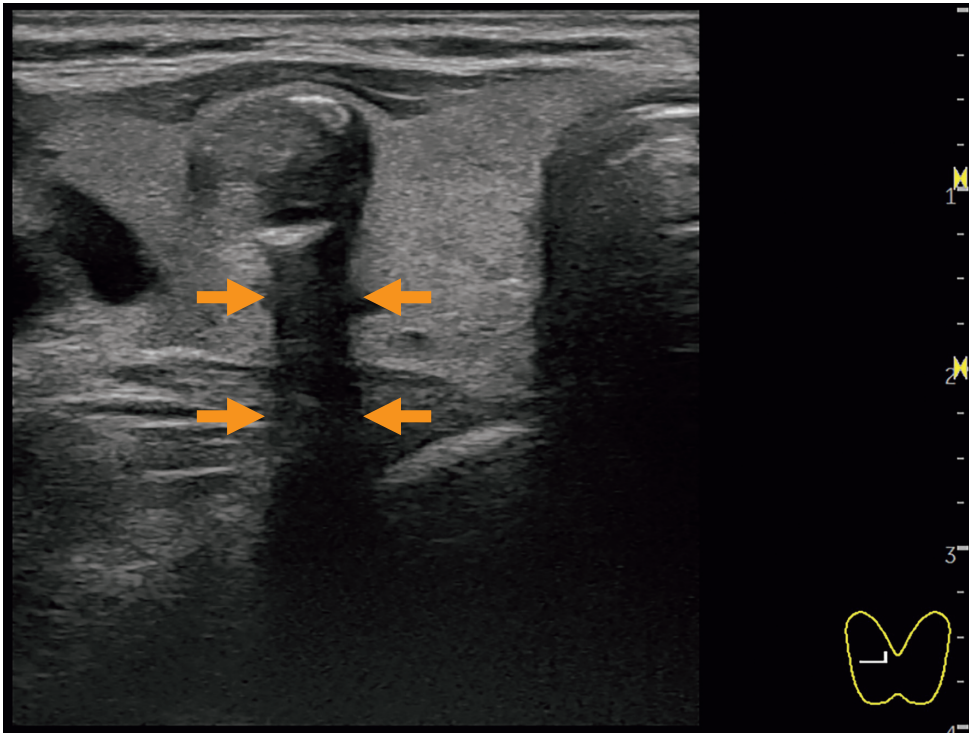

No. 6

(問題 15)

省 略

No. 7

(問題 28)

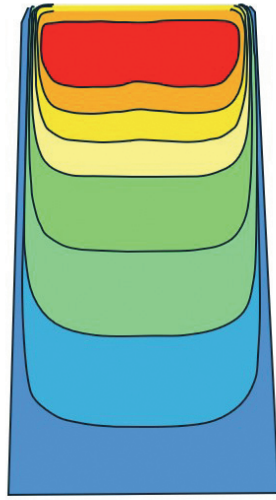
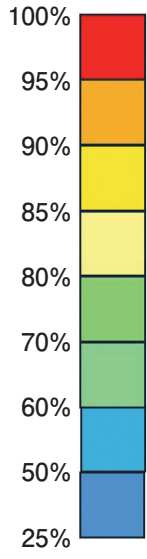

A

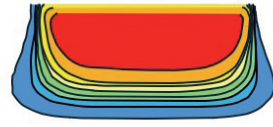

B

No. 8

(問題 29)

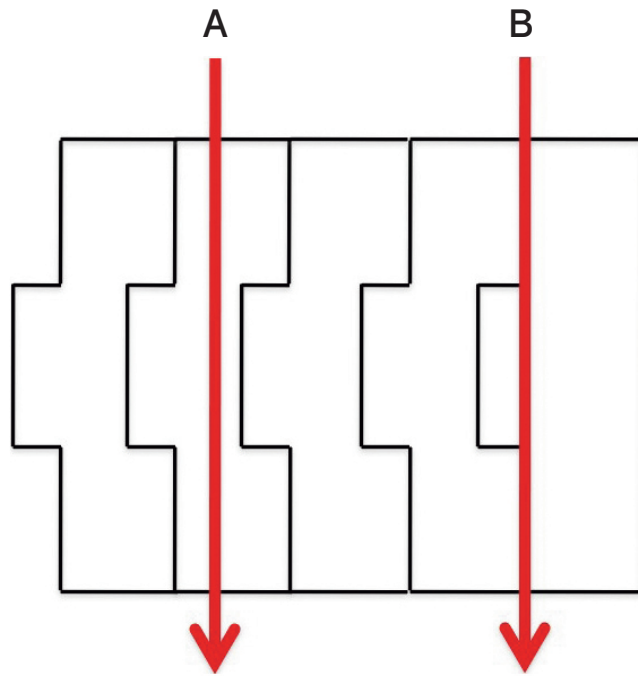

このページは余白です

No. 9 (問題 88)

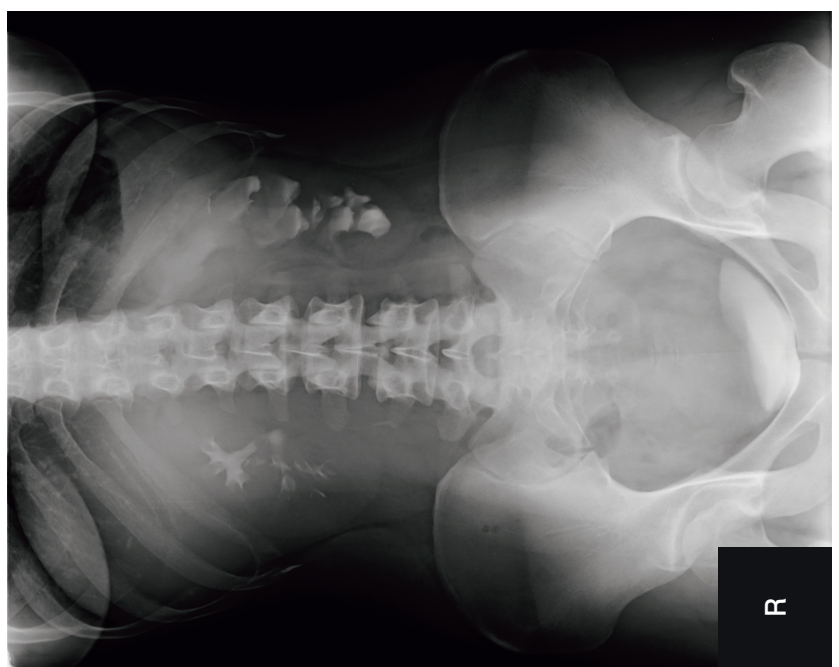
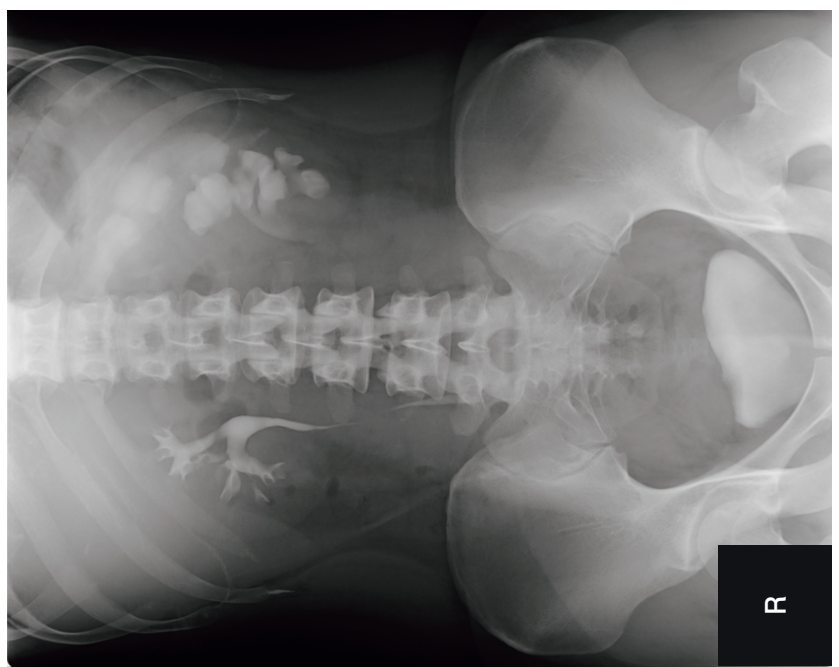

No. 9 (問題 88)

