

(別紙 1) 業務フロー

健康管理業務フロー一覧 (46フロー)

区分	大分類	小分類	頁番号
1 健康管理	02 【成人保健】対象者管理	01 検診案内 (希望制)	1
		02 検診案内 (一括抽出)	
		03 個別受付 (電話・はがき)	
		04 個別受付 (電子申請)	
		05 個別受付 (窓口)	
	03 【成人保健】検診情報管理	01 検診結果入力 (個別検診)	6
		02 検診結果入力 (集団検診)	
		03 結果票作成	
		04 未受診者勧奨	
	04 【成人保健】精密検査情報管理	01 精密検査結果入力	10
		02 未受診者勧奨	
	05 【成人保健】訪問・相談・教育	01 訪問(対象者抽出)	12
02 訪問(住民申込)			
03 相談			
04 教育			
06 【母子保健】妊産婦管理	01 妊娠届・母子手帳交付 (窓口等)	16	
	02 妊娠届・母子手帳交付 (電子申請)		
	03 妊婦健診結果入力		
	04 妊婦精密健診結果入力		
	05 産婦健診結果入力		
	06 産婦精密健診結果入力		
	07 産後ケア事業		
07 【母子保健】乳幼児管理	01 出生時状況	23	
	02 新生児聴覚スクリーニング検査		
	03 乳幼児健診の案内		
	04 乳幼児健診結果入力 (個別健診)		
	05 乳幼児健診結果入力 (集団健診)		
	06 乳幼児精密健診結果入力		
	07 未受診者勧奨		
08 【母子保健】訪問・相談・教育・フォロー	01 訪問 (対象者抽出)	30	
	02 訪問 (住民申込)		
	03 相談		
	04 教育 (対象者抽出)		
	05 教育 (住民申込)		
	06 フォロー		
09 【母子保健】養育医療管理	01 養育医療申請・実施	36	
10 【予防接種】対象者管理	01 予診票一括発行 (冊子渡し)	37	
	02 予診票一括発行 (接種別発送)		
	03 窓口発行		
	04 新型コロナウイルス接種券発行		
11 【予防接種】接種情報管理	01 接種結果入力	41	
	02 未接種者推奨		
	03 接種証明書発行		
	04 新型コロナウイルス接種結果入力		
	05 健康被害救済制度		
12 統計・報告	01 報告資料作成	46	

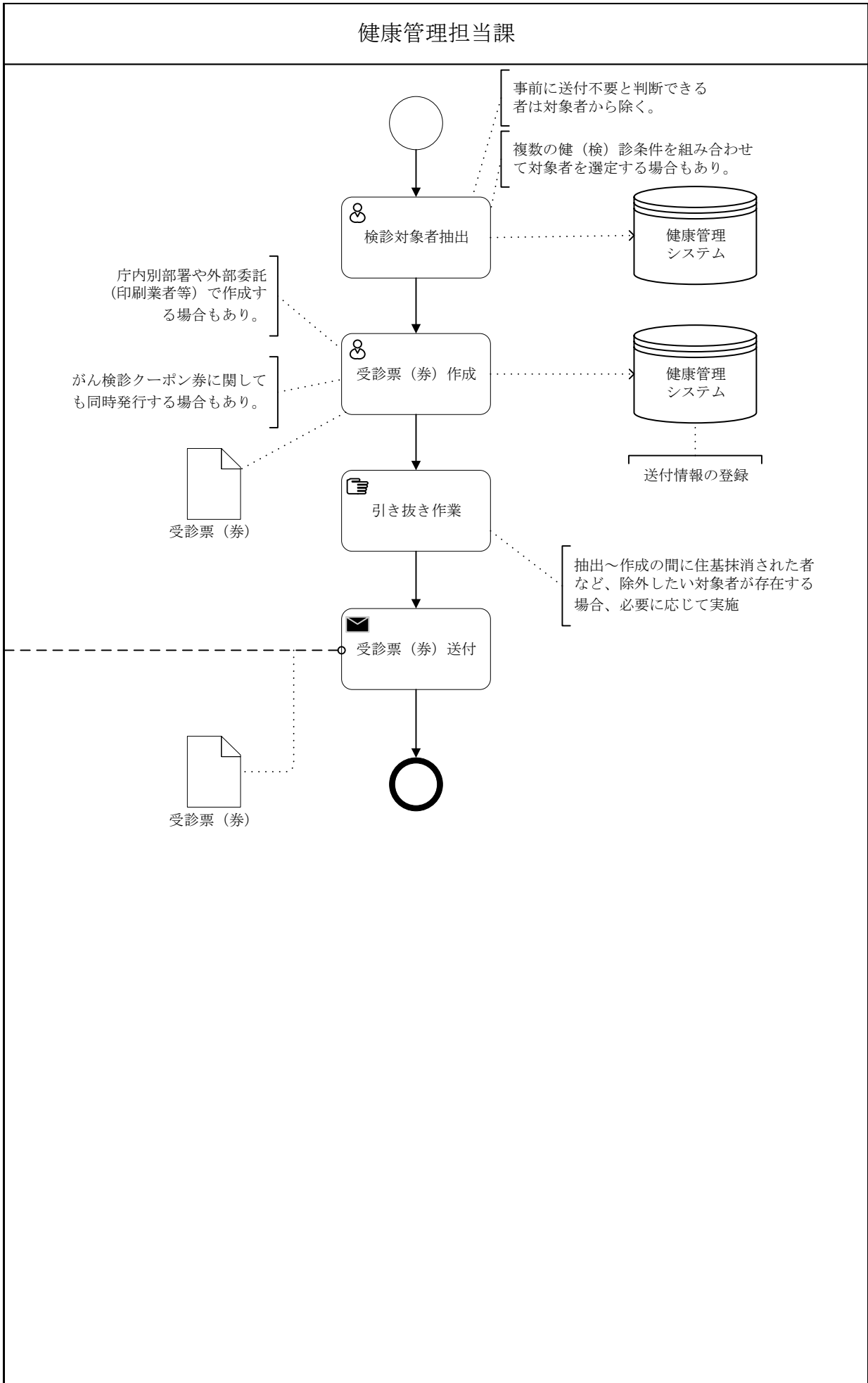

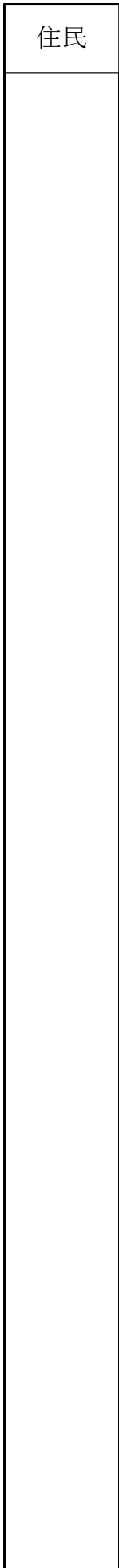
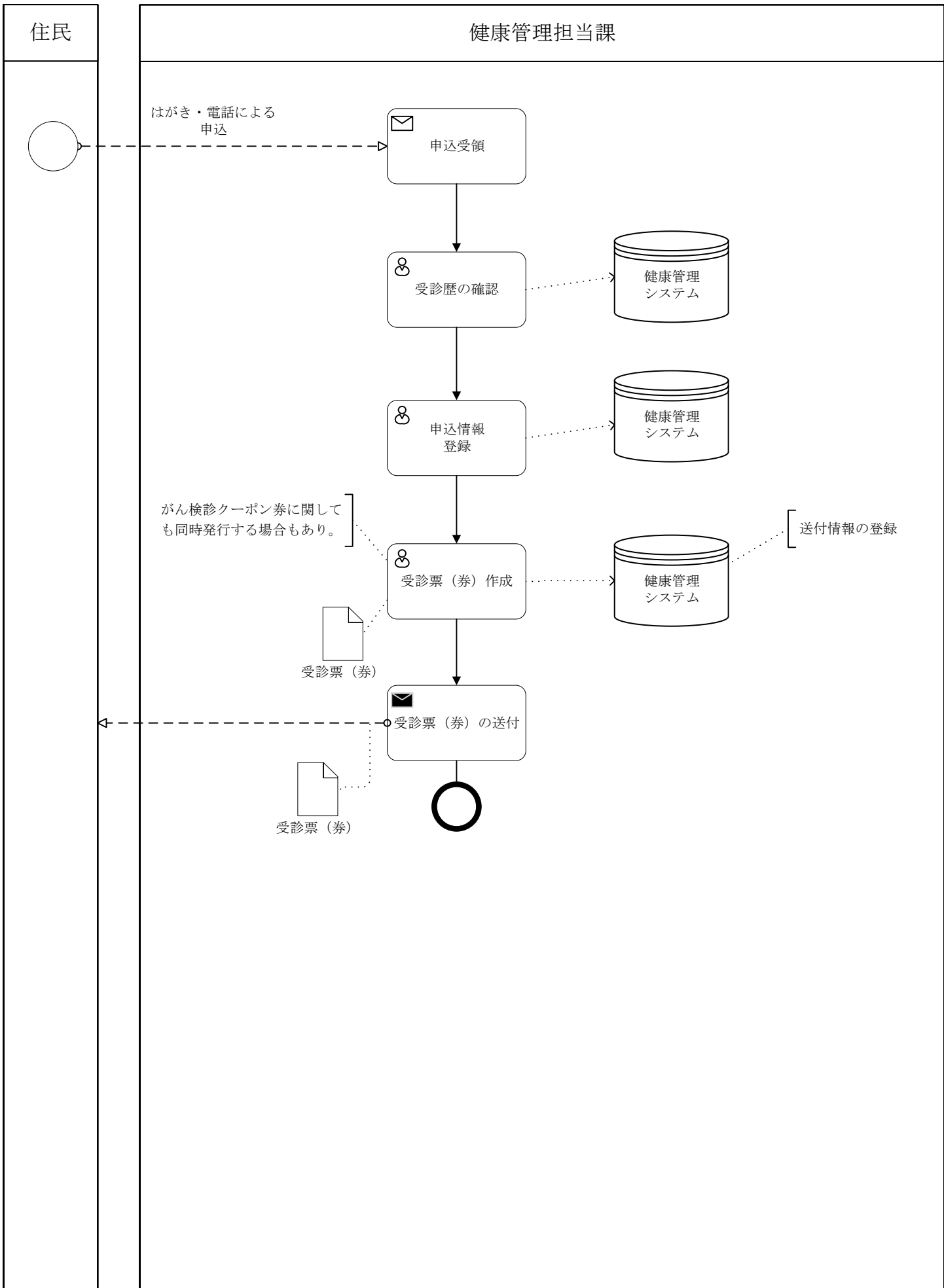

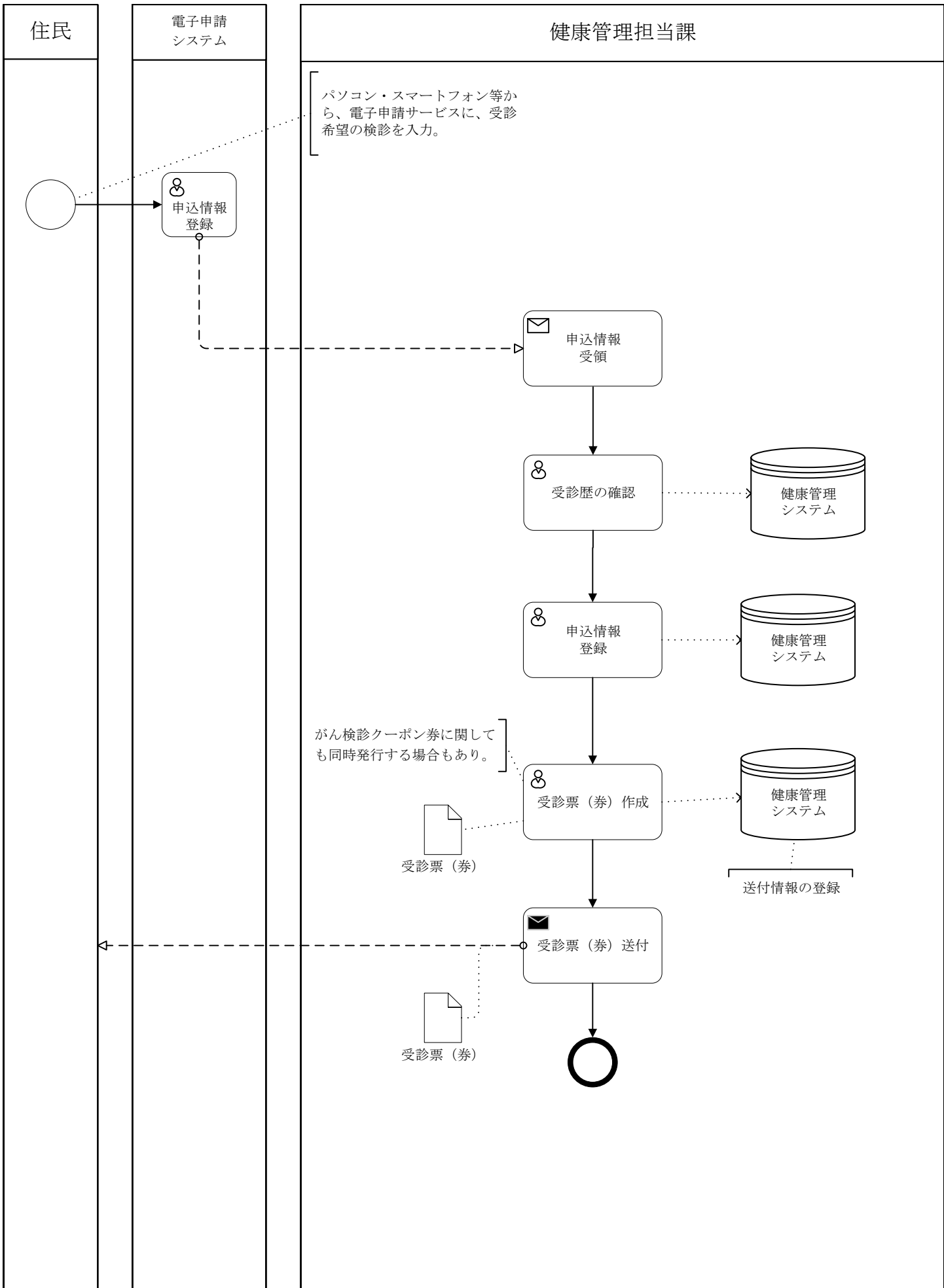

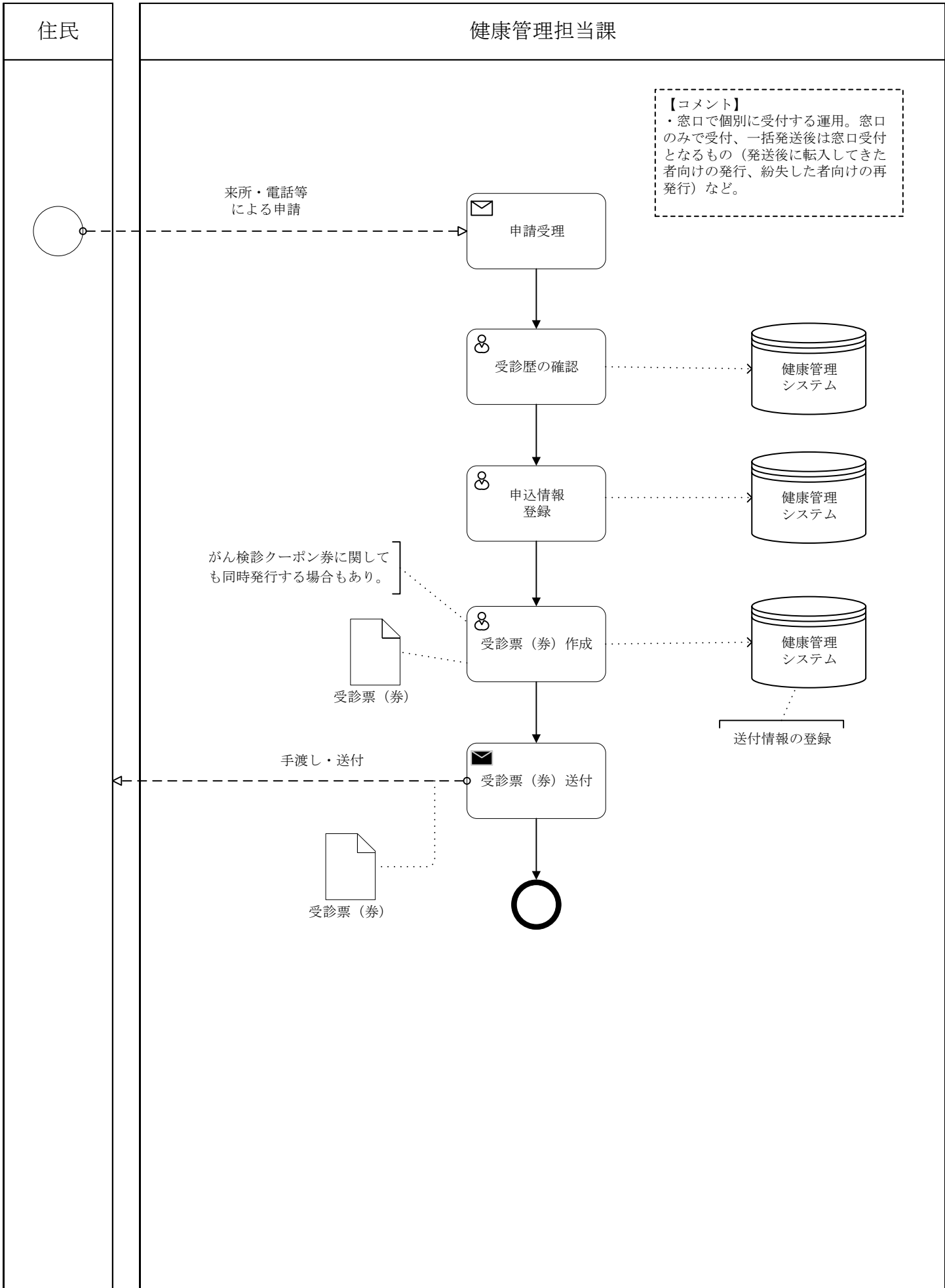

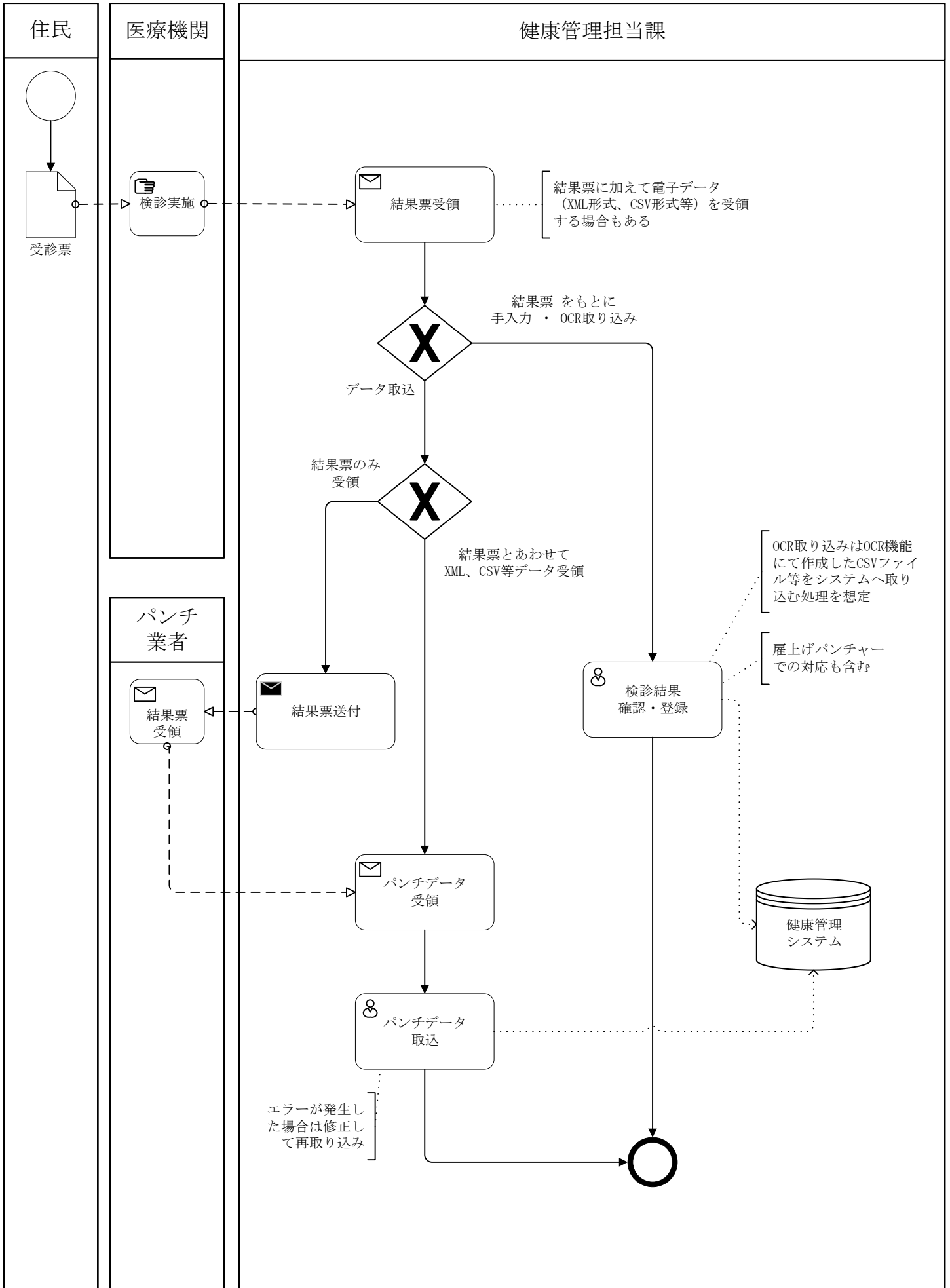

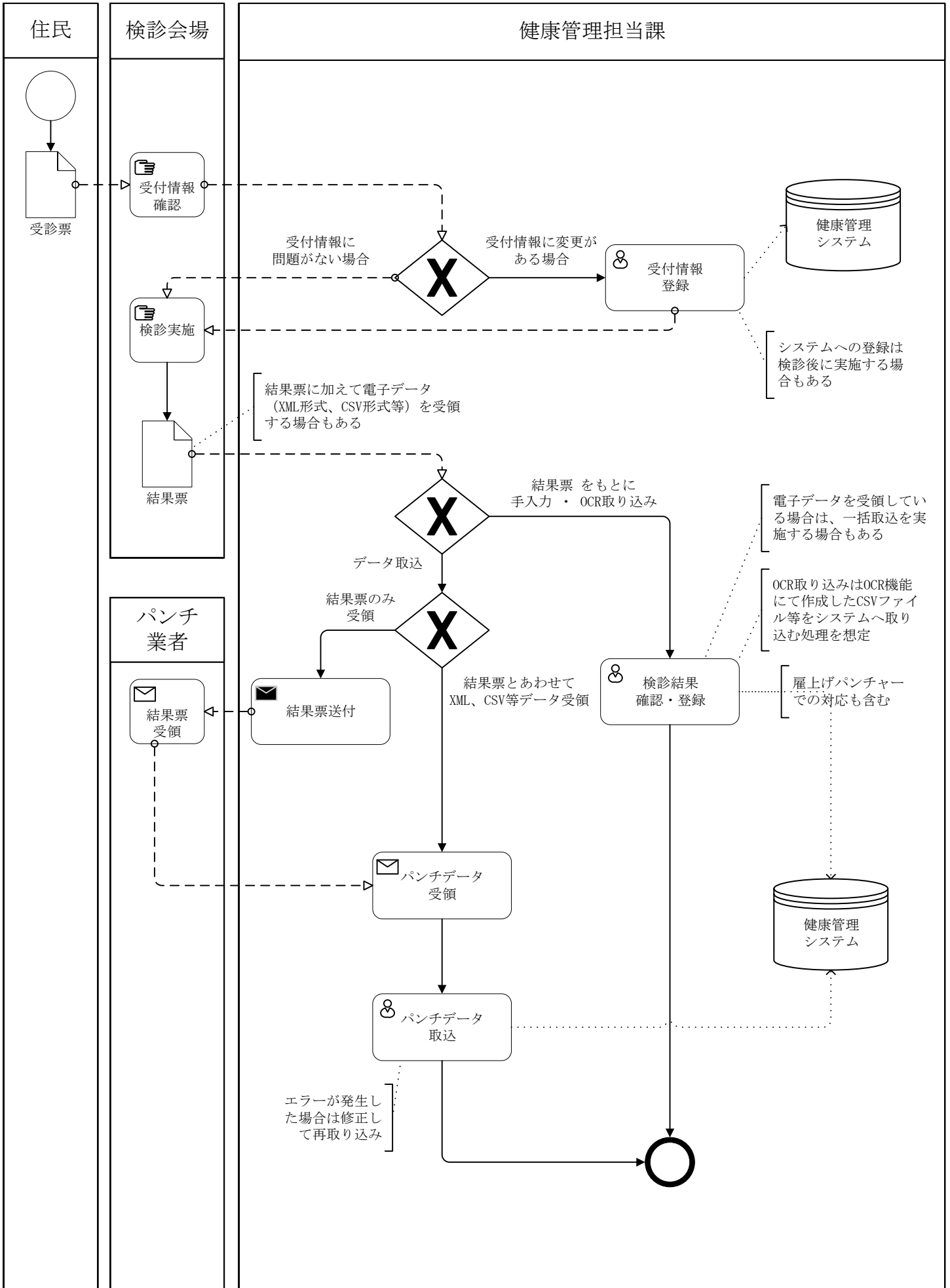

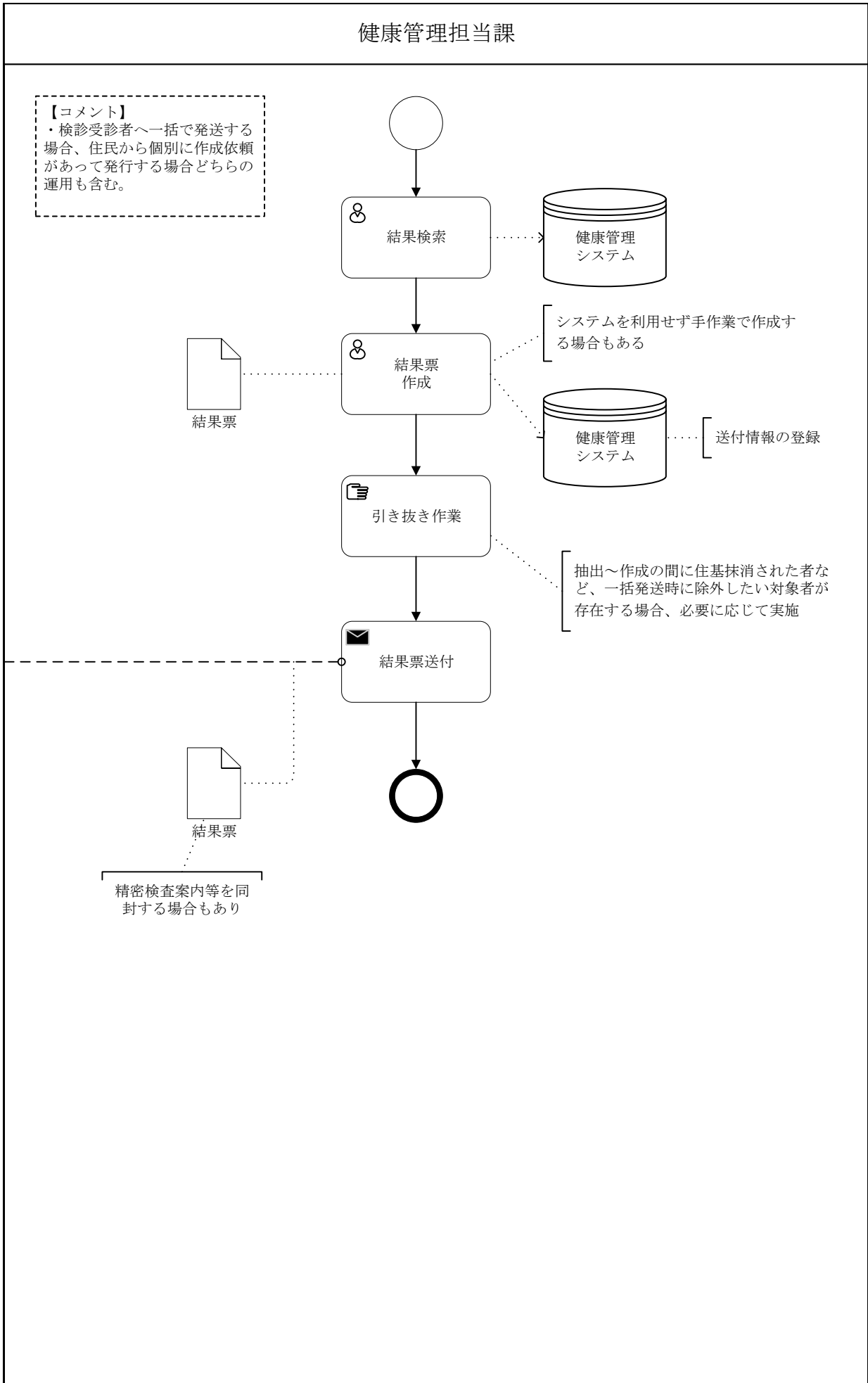
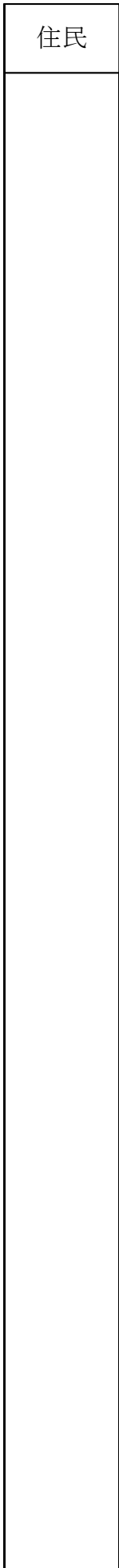

住民

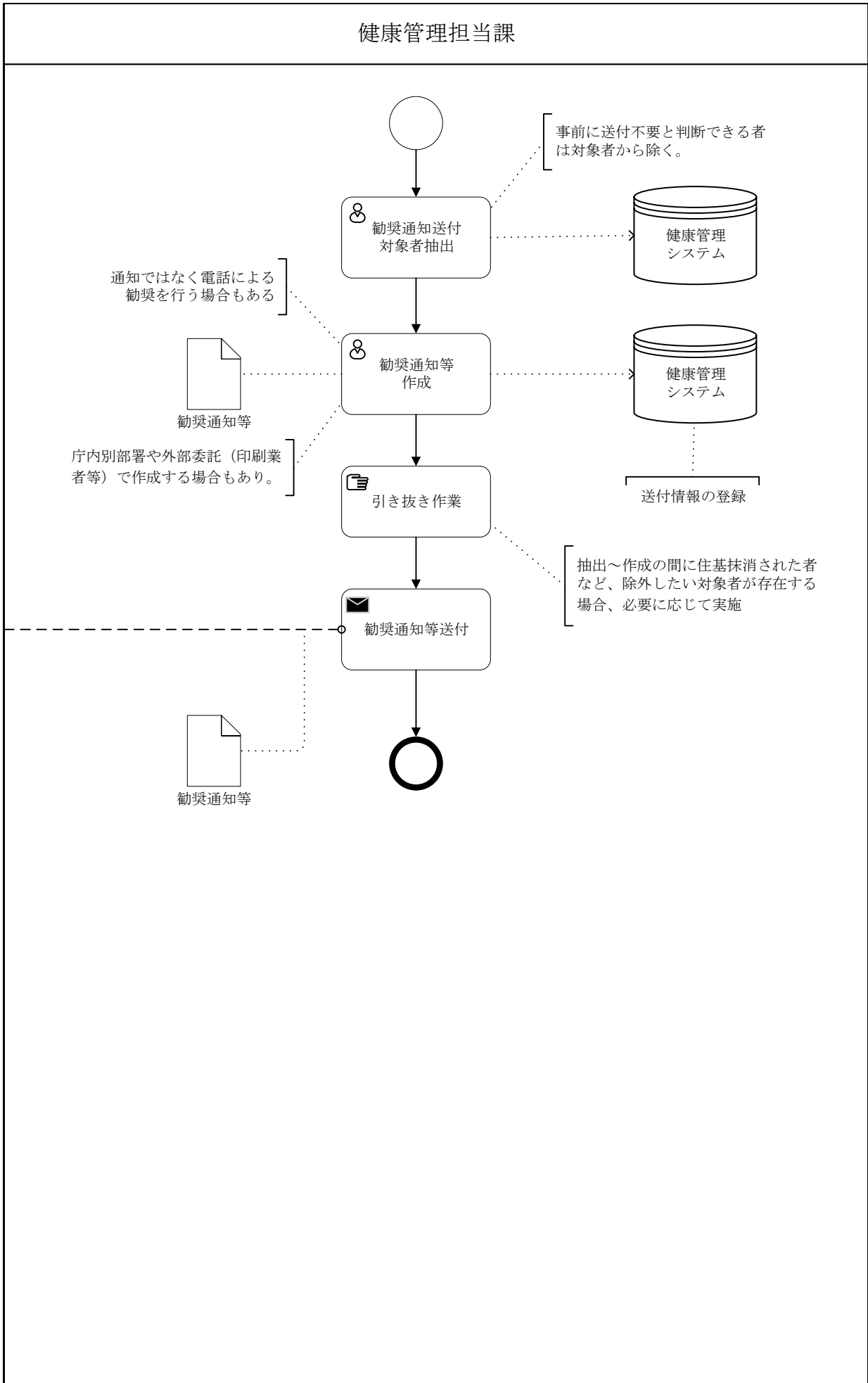

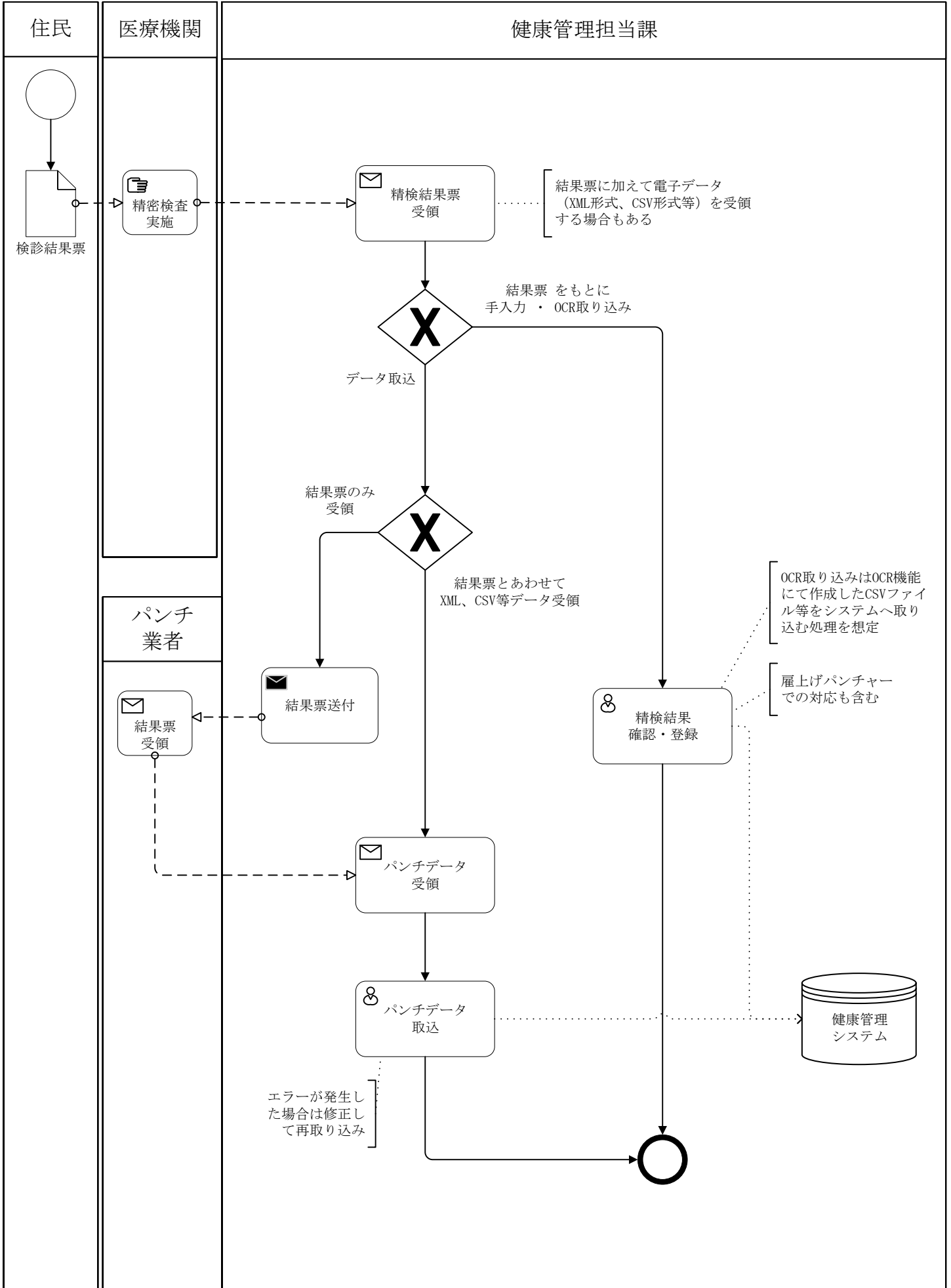

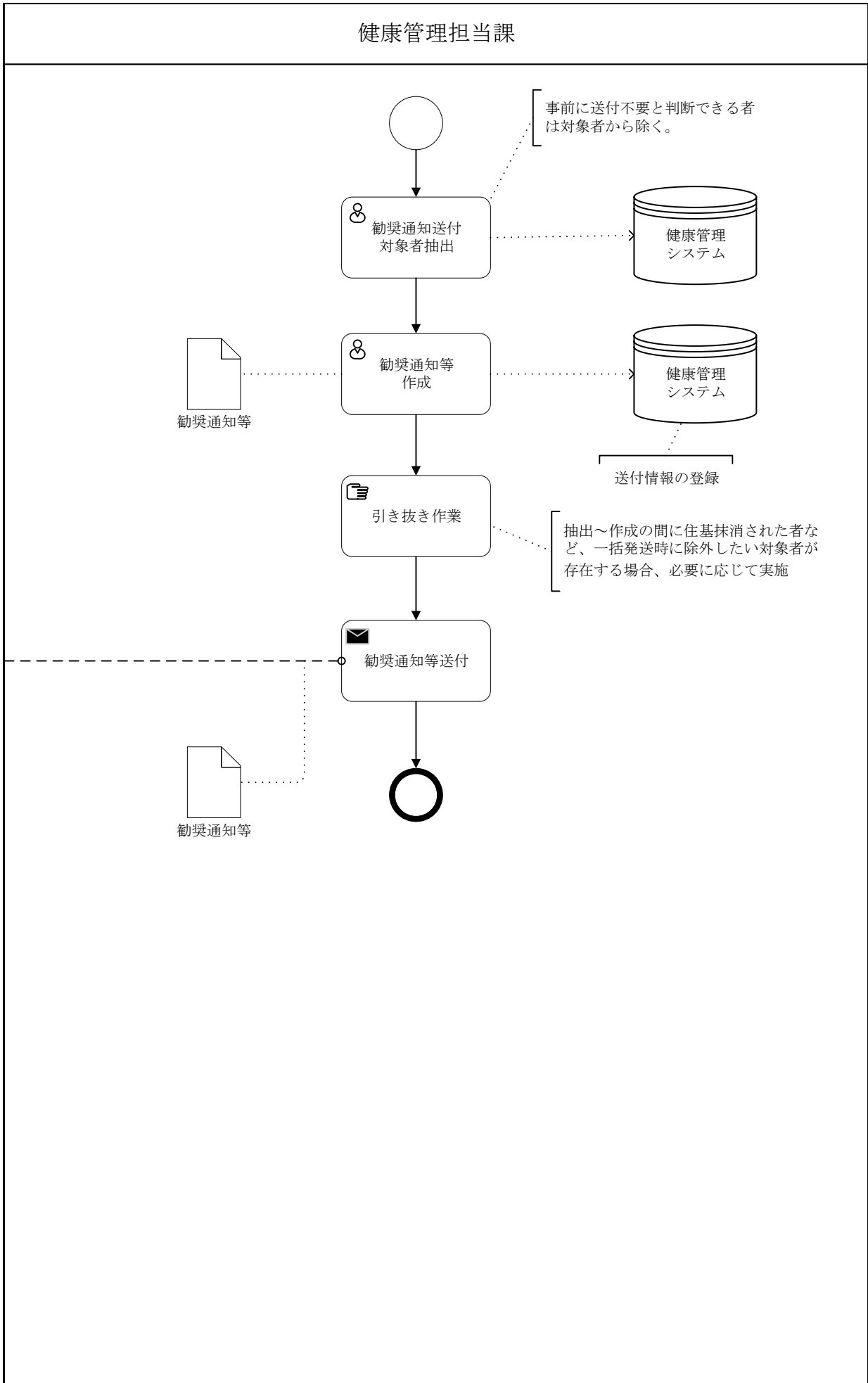
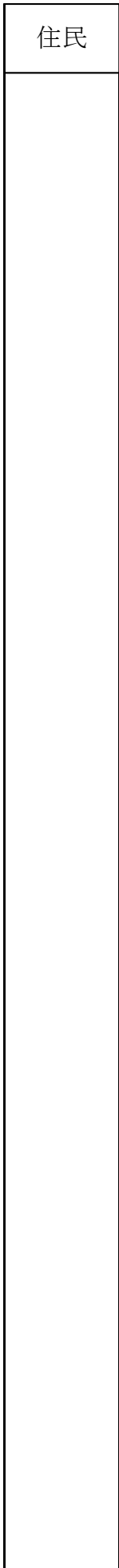

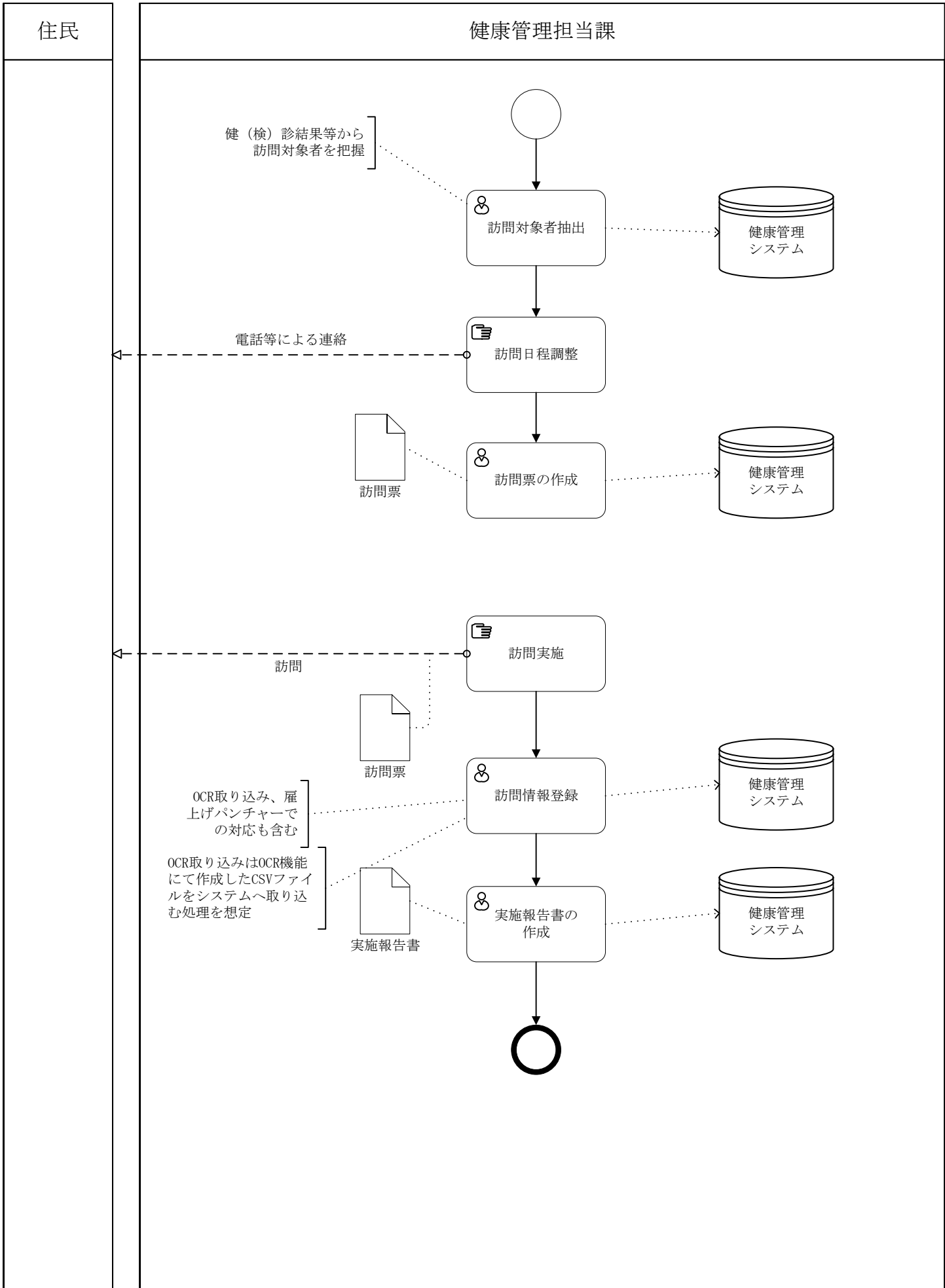

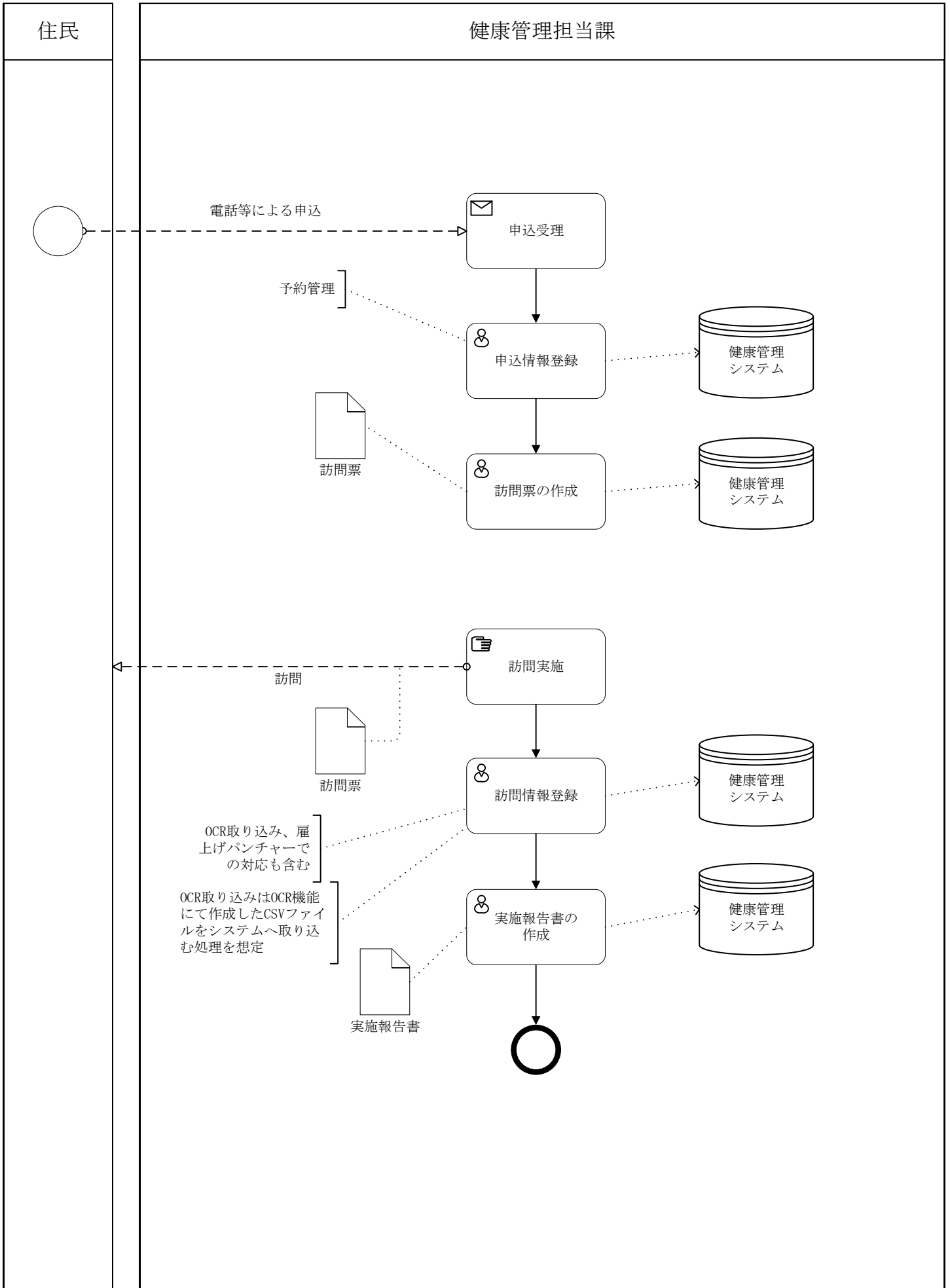

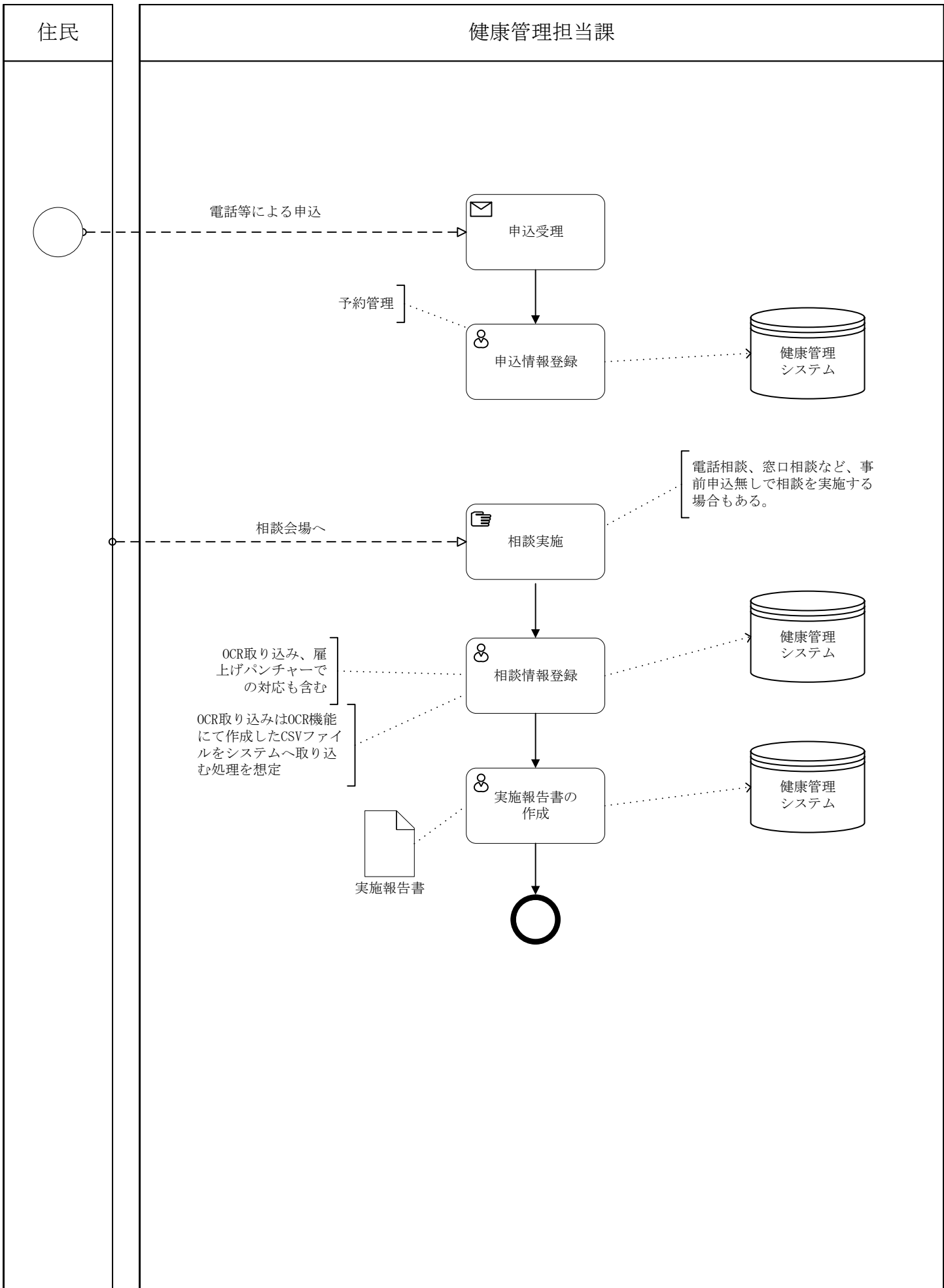

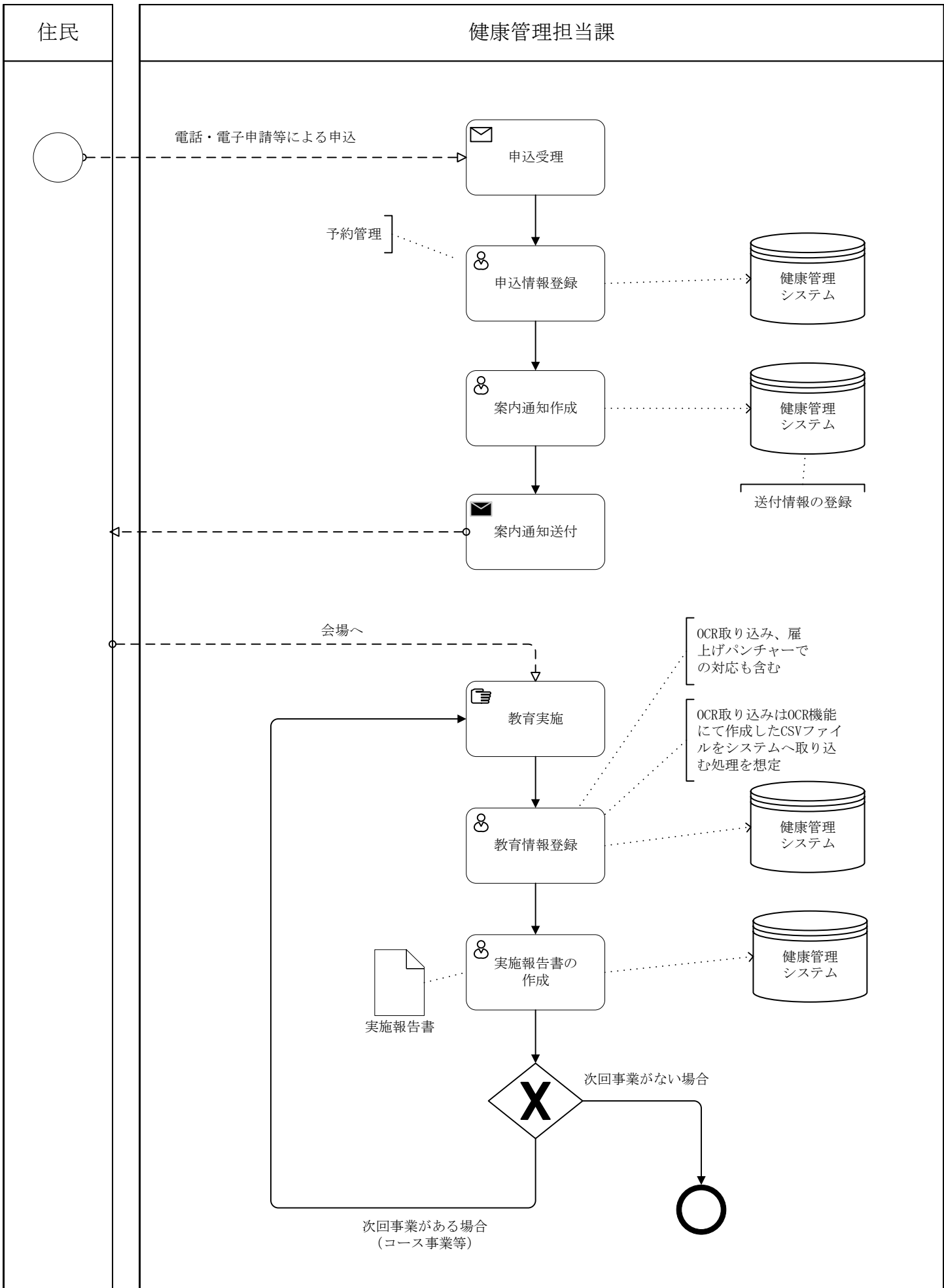

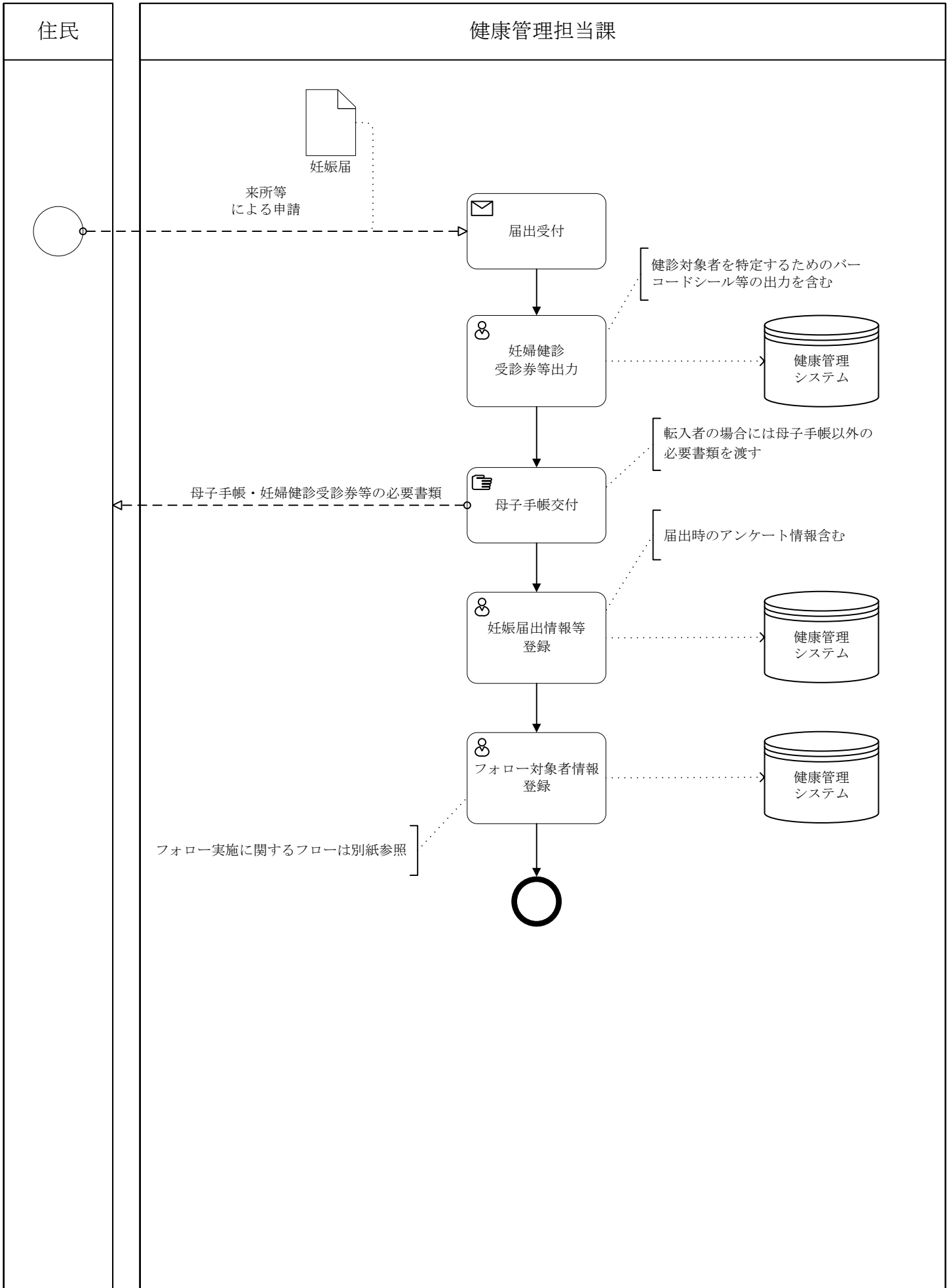

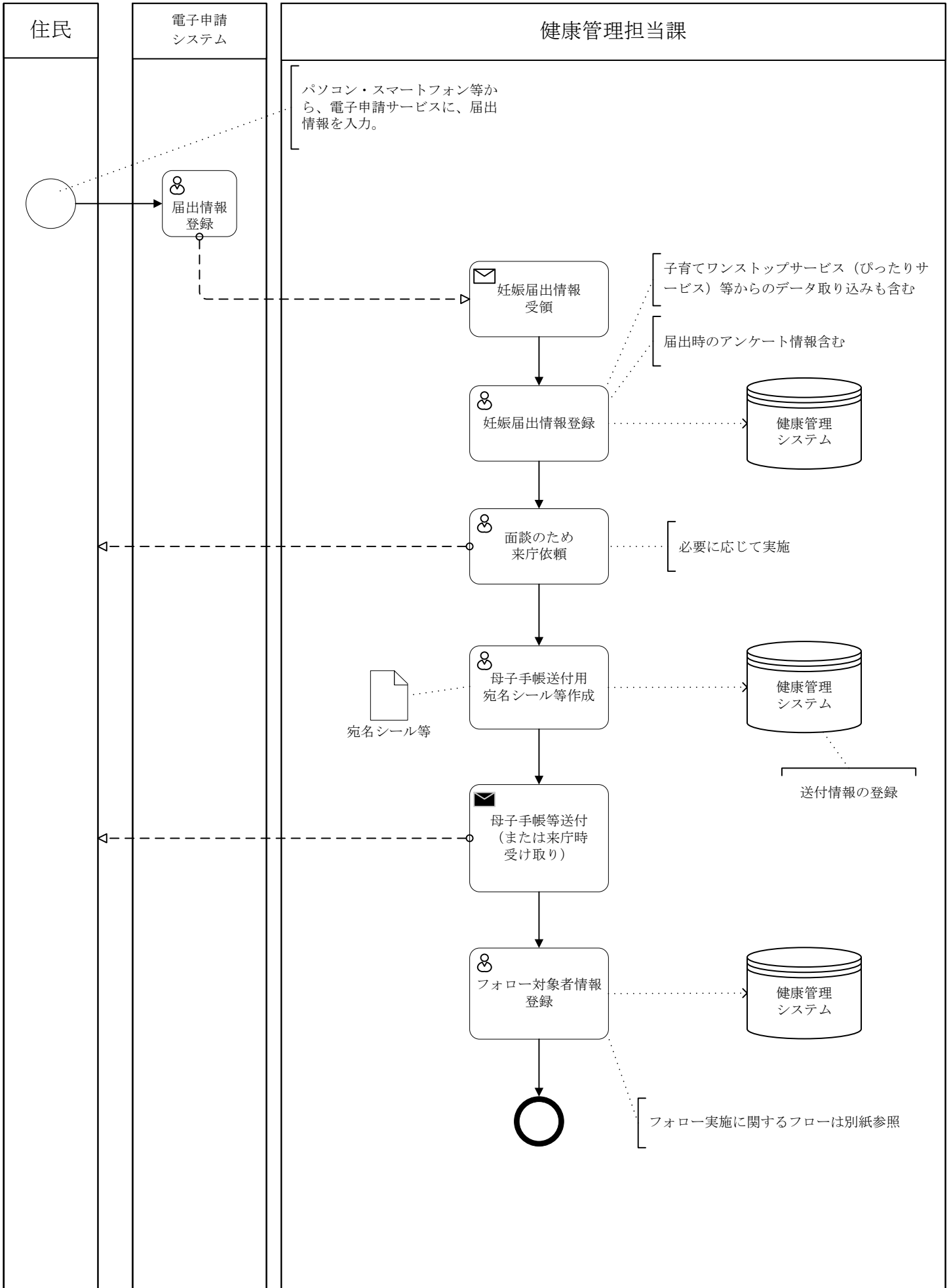

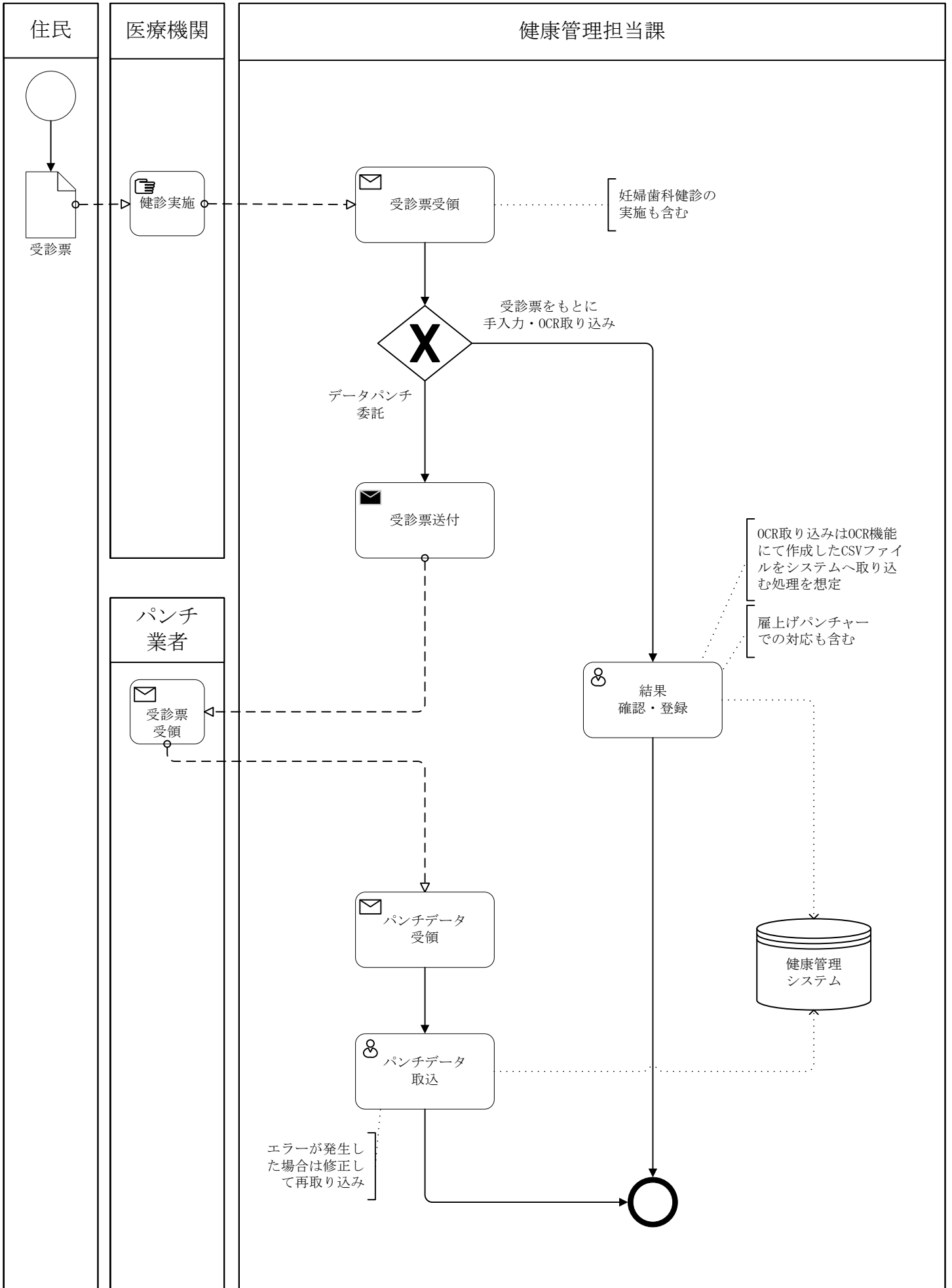

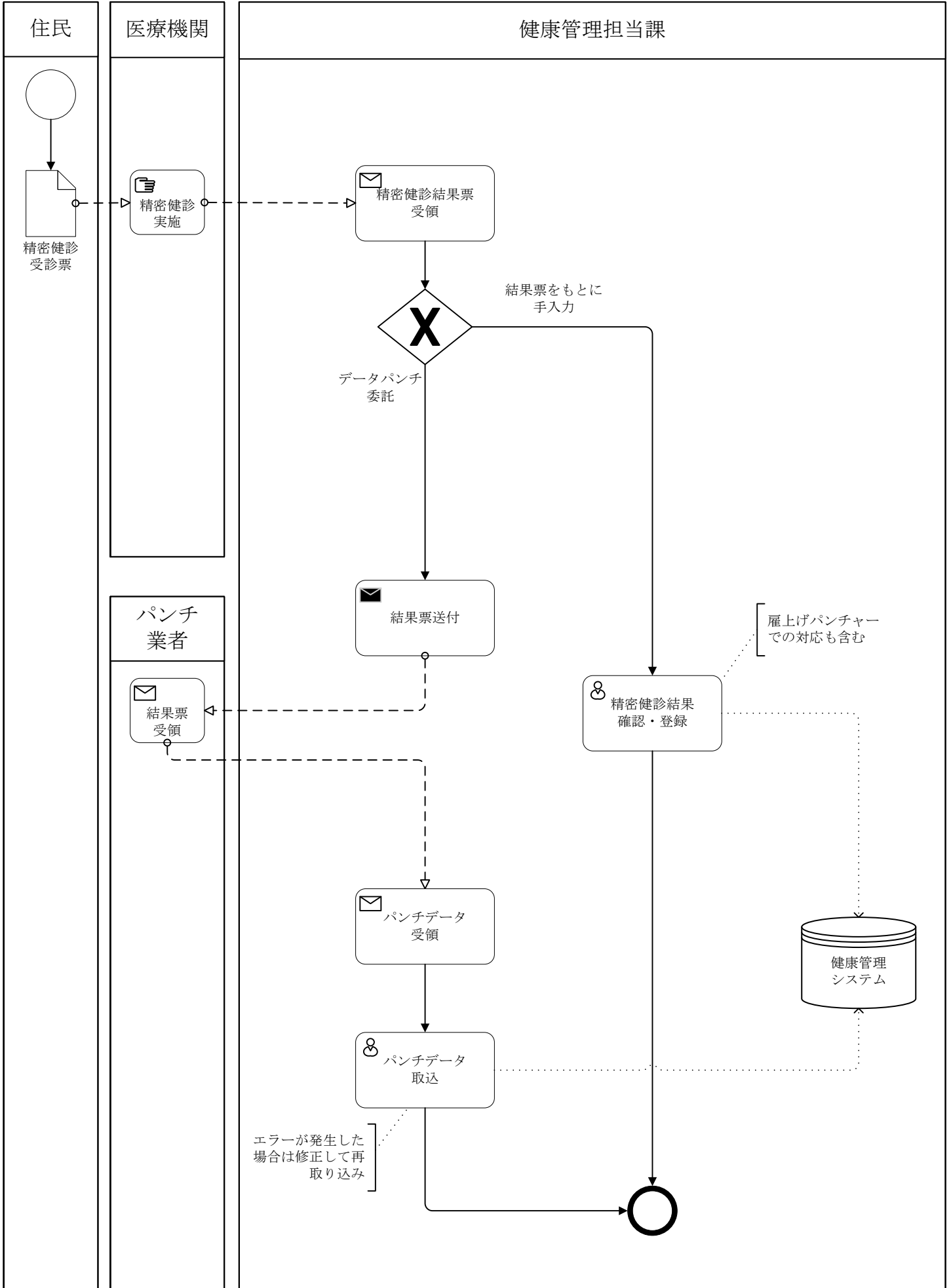

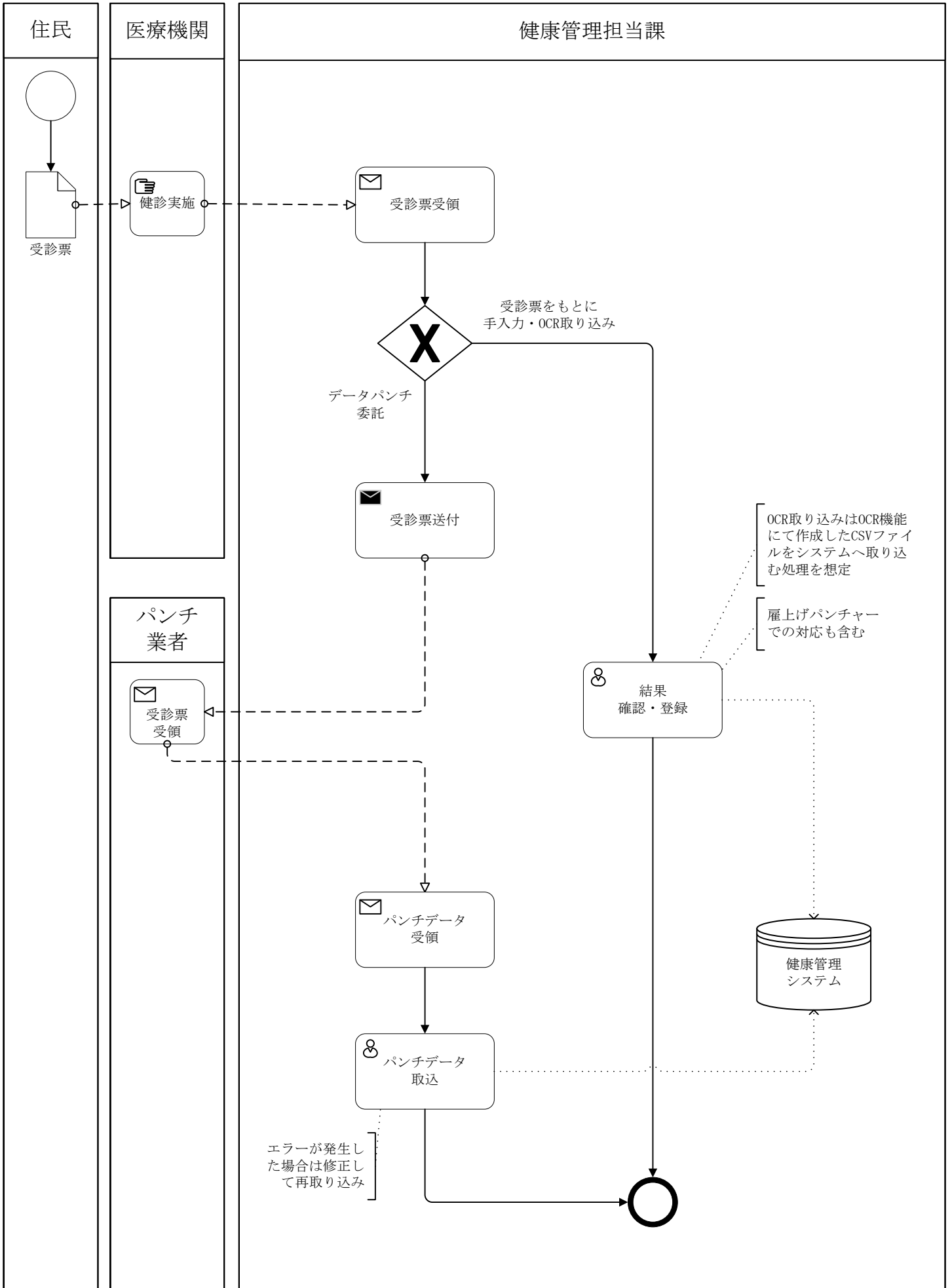

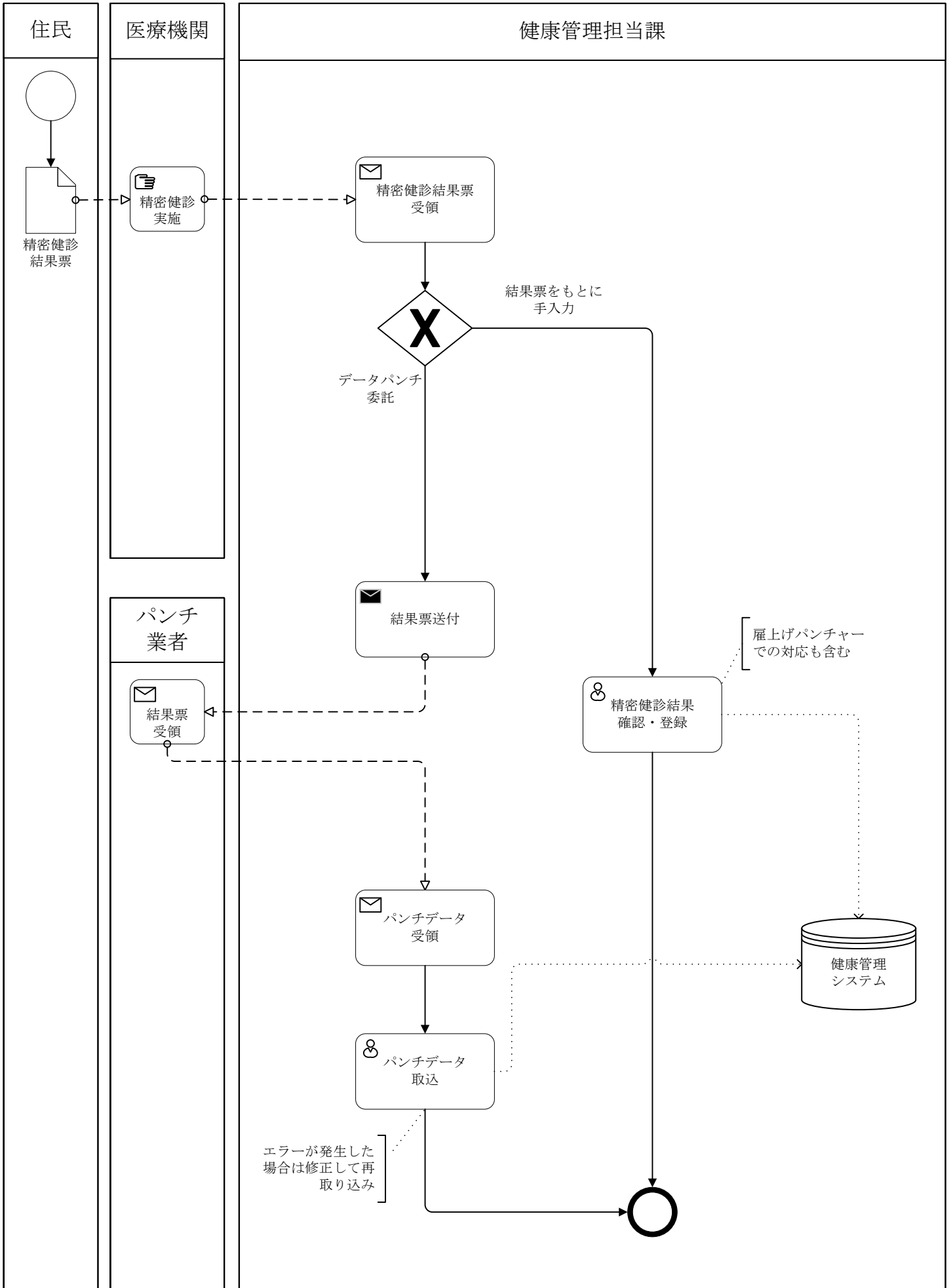

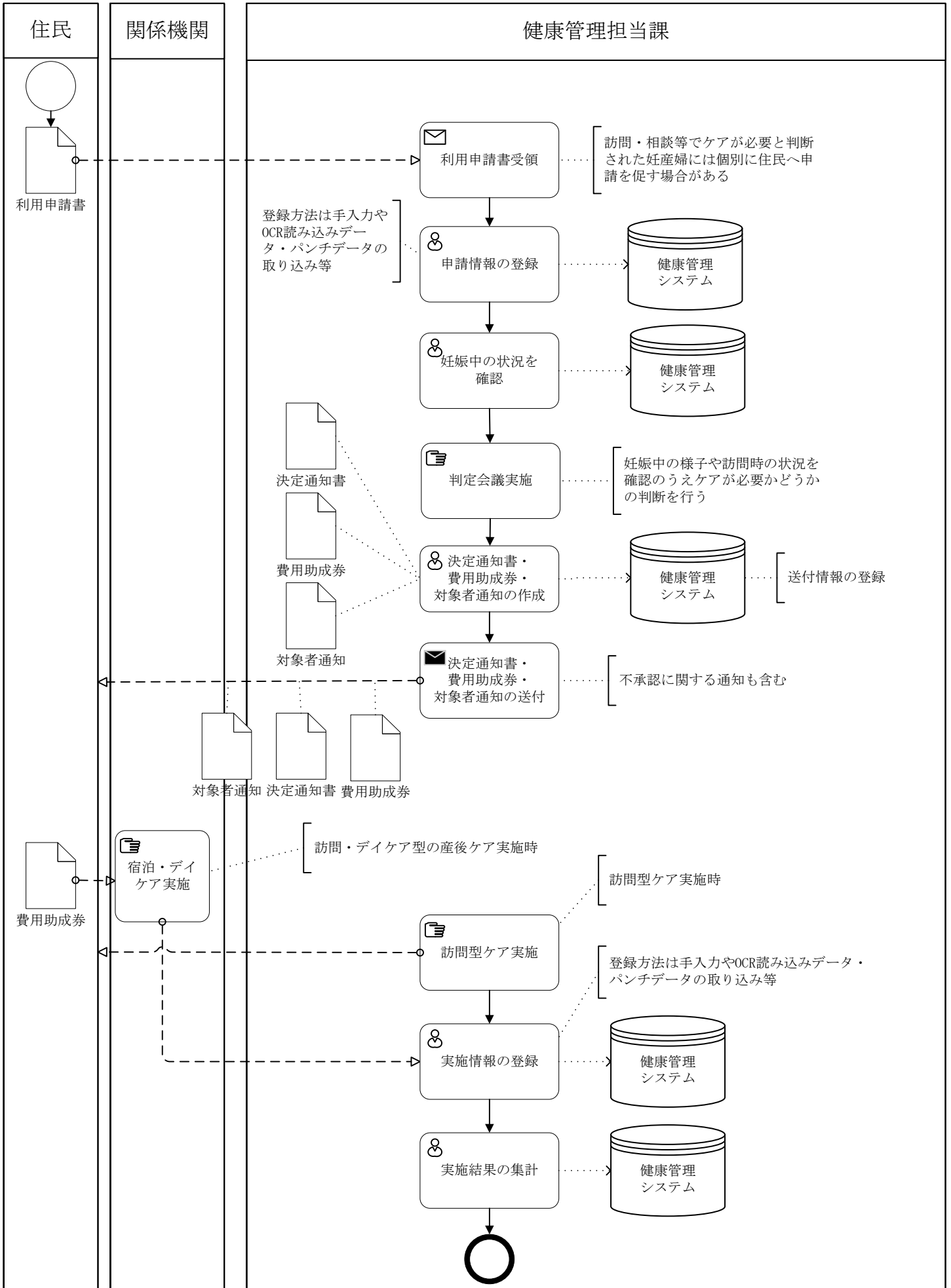

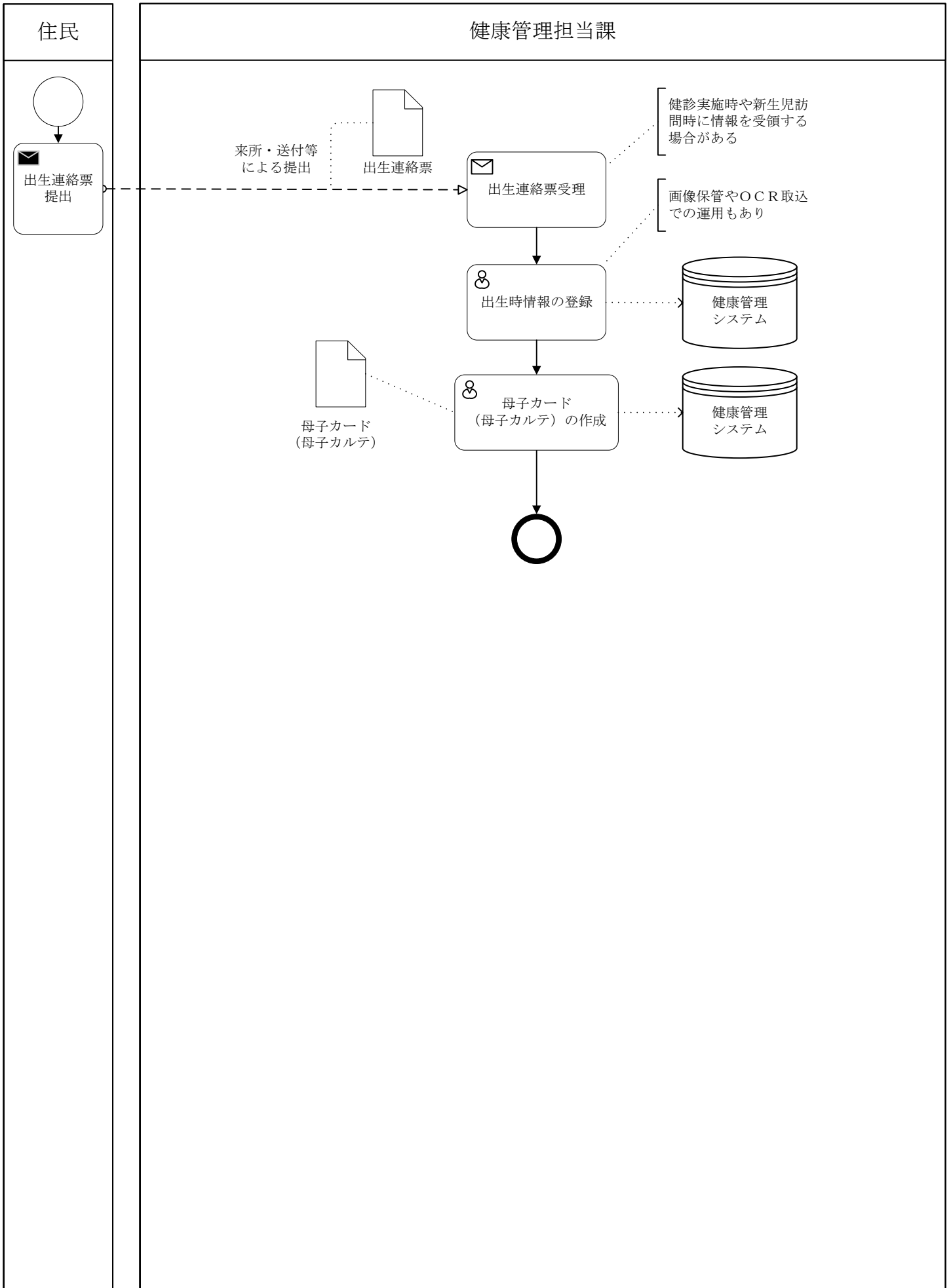

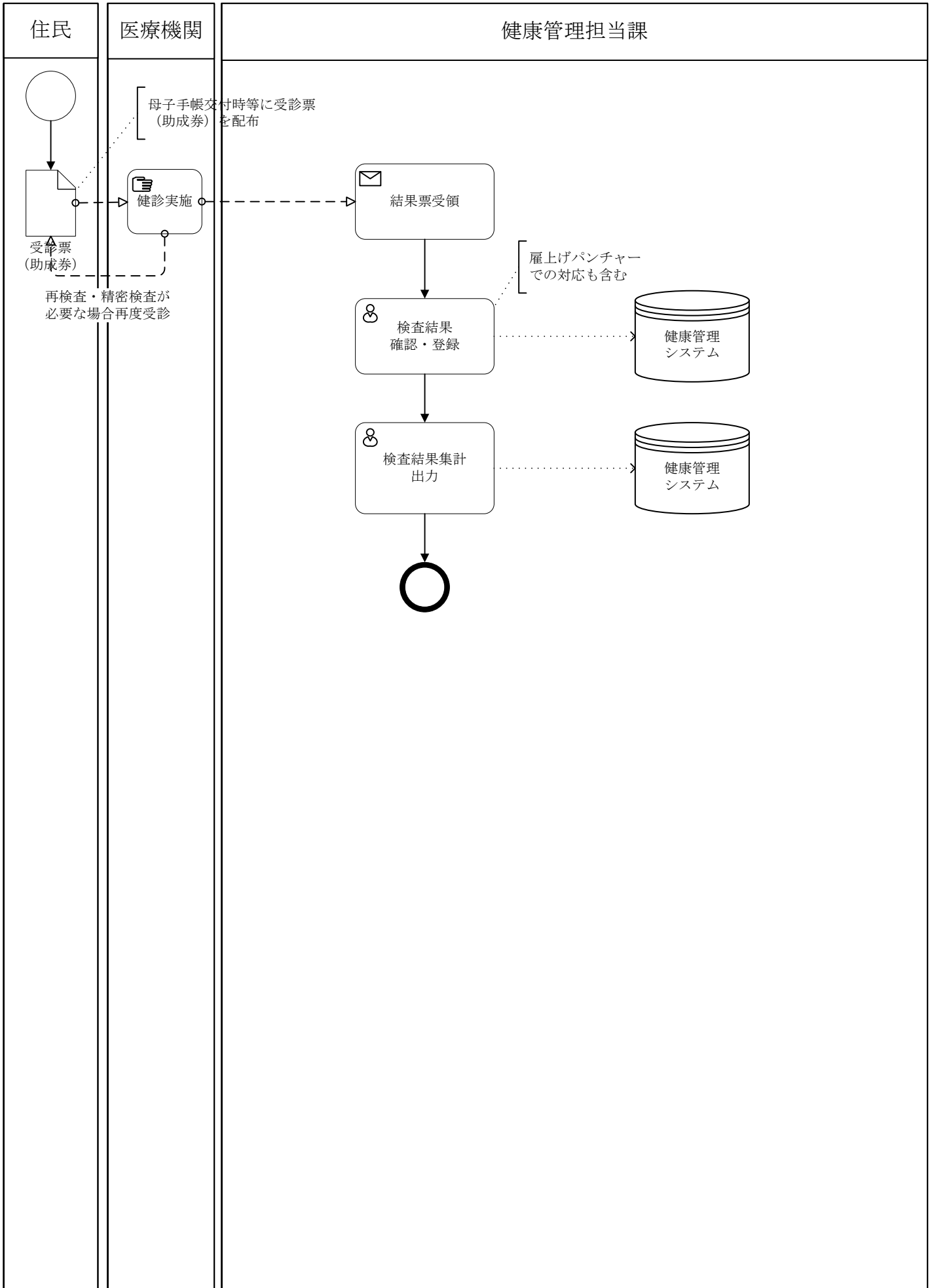

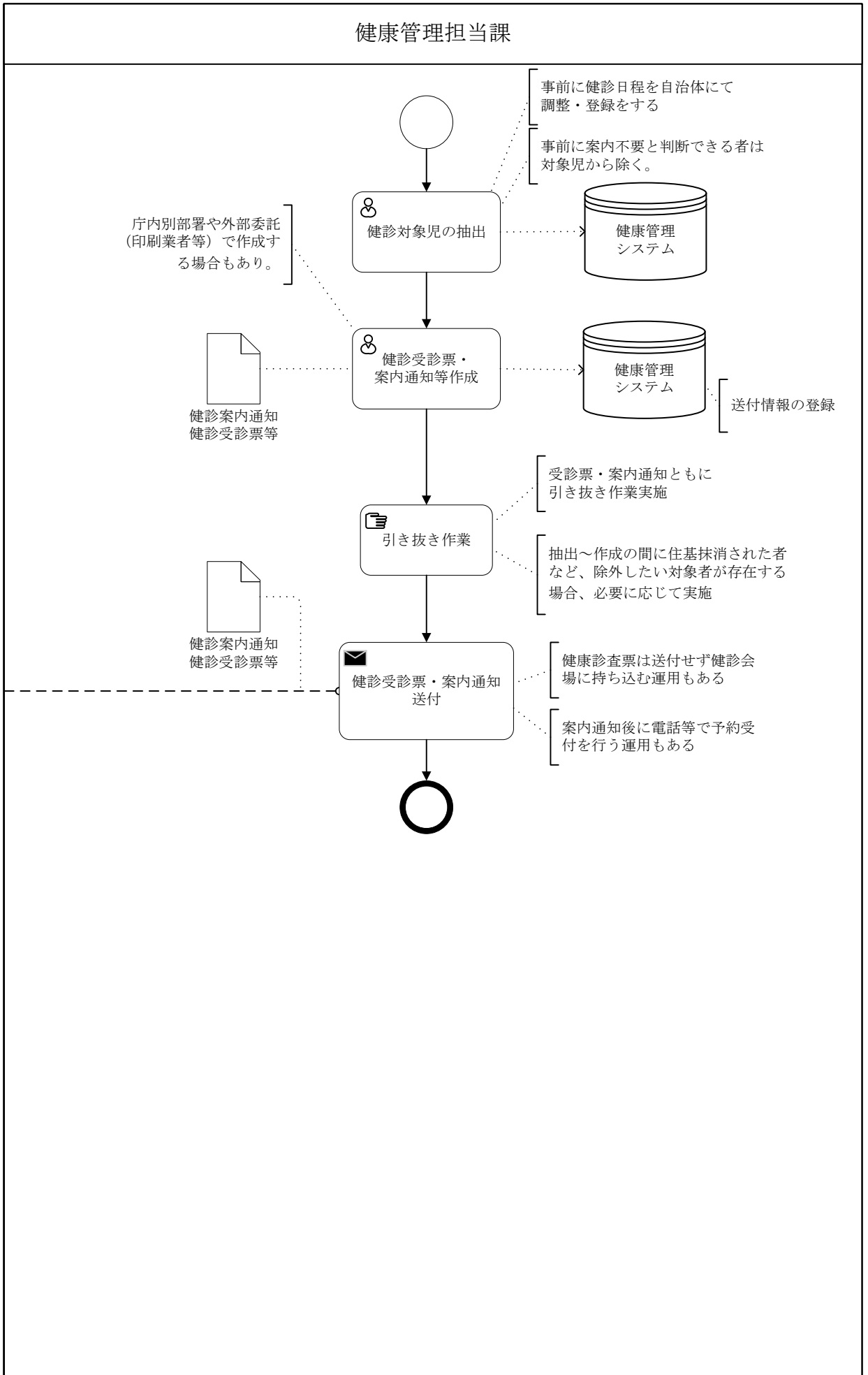

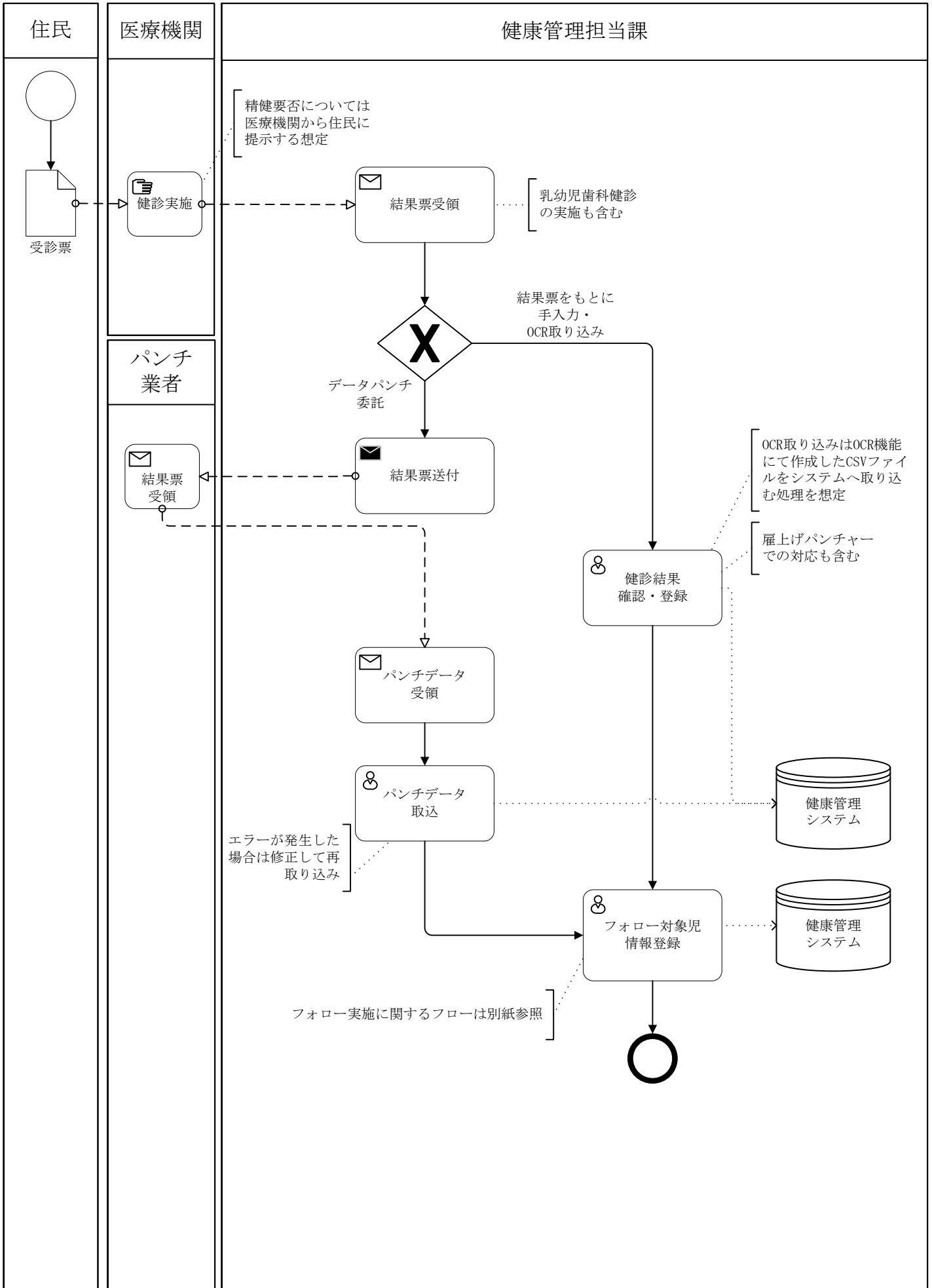

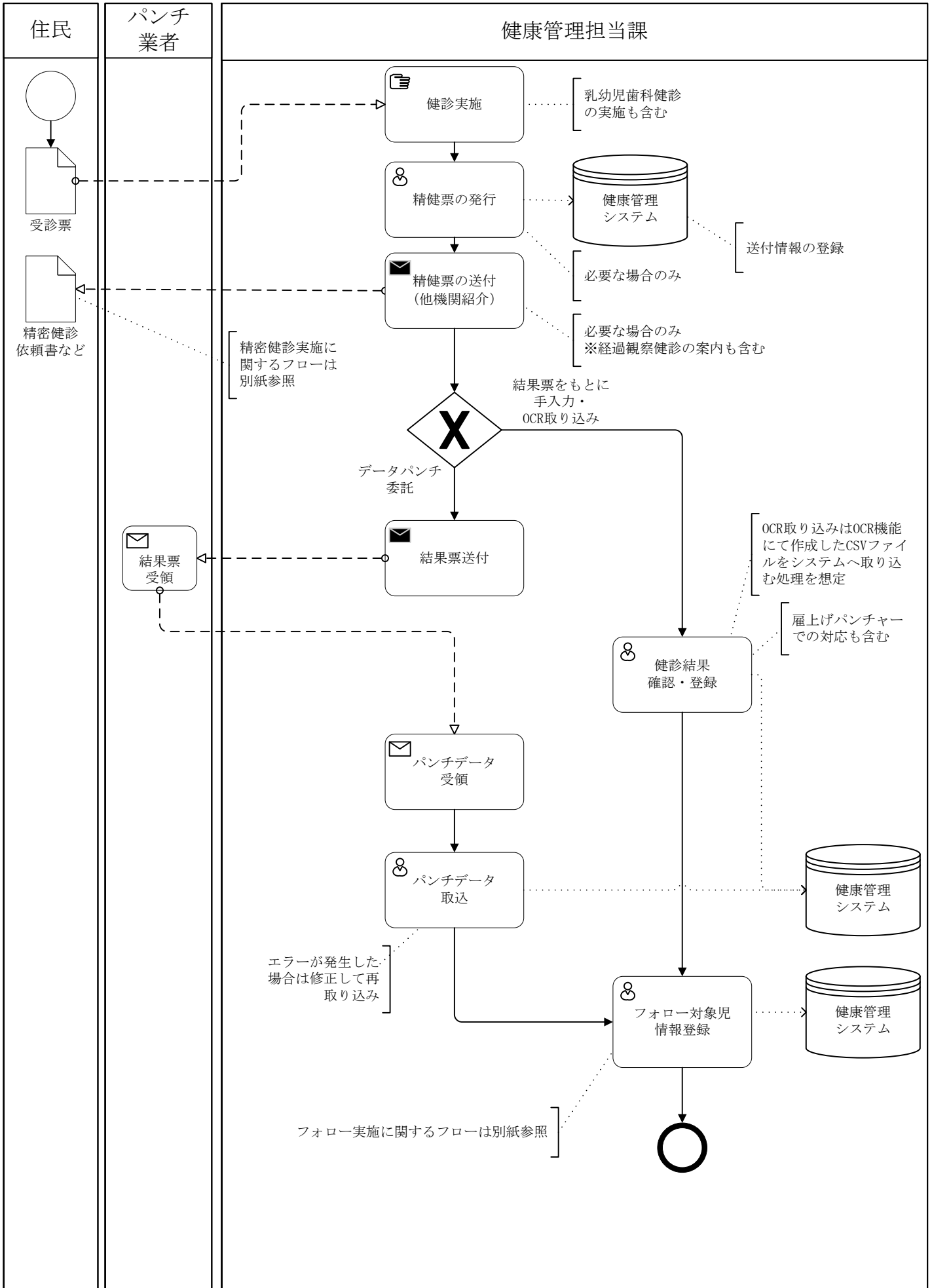

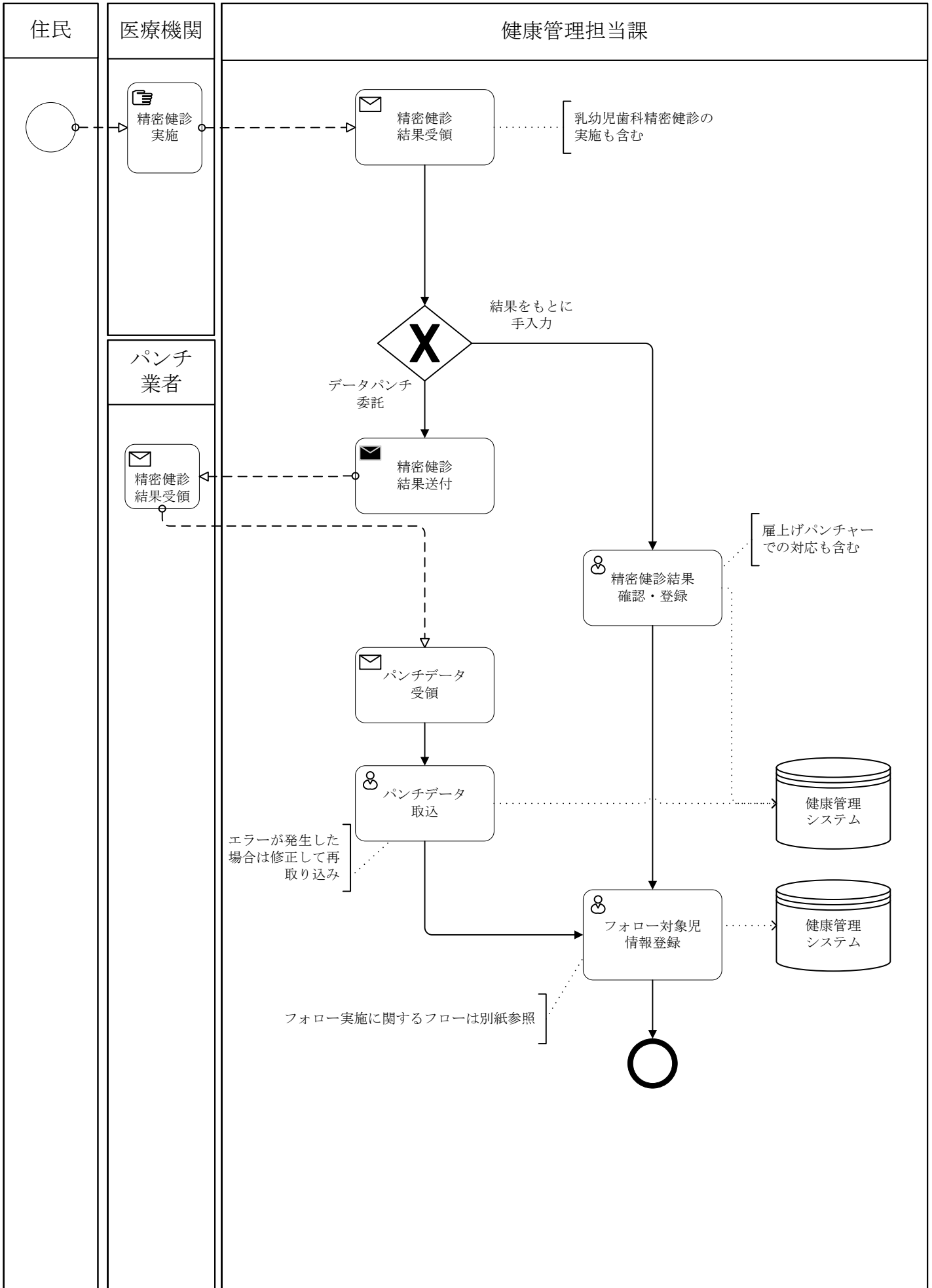

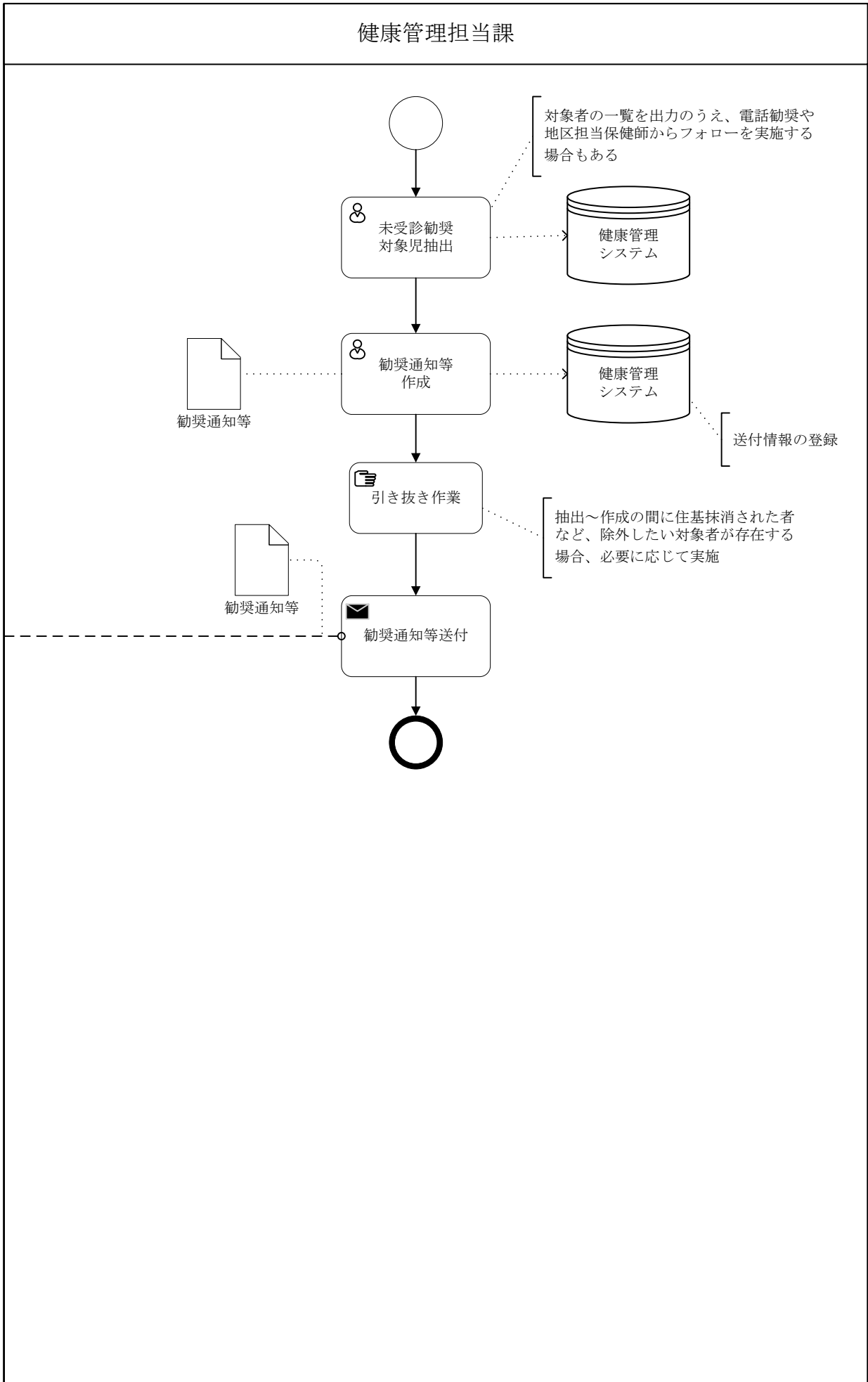
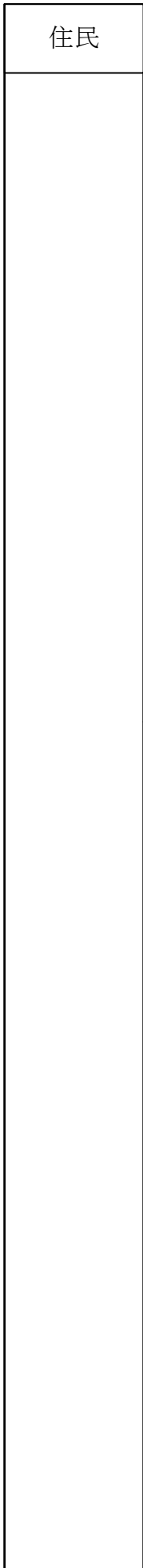

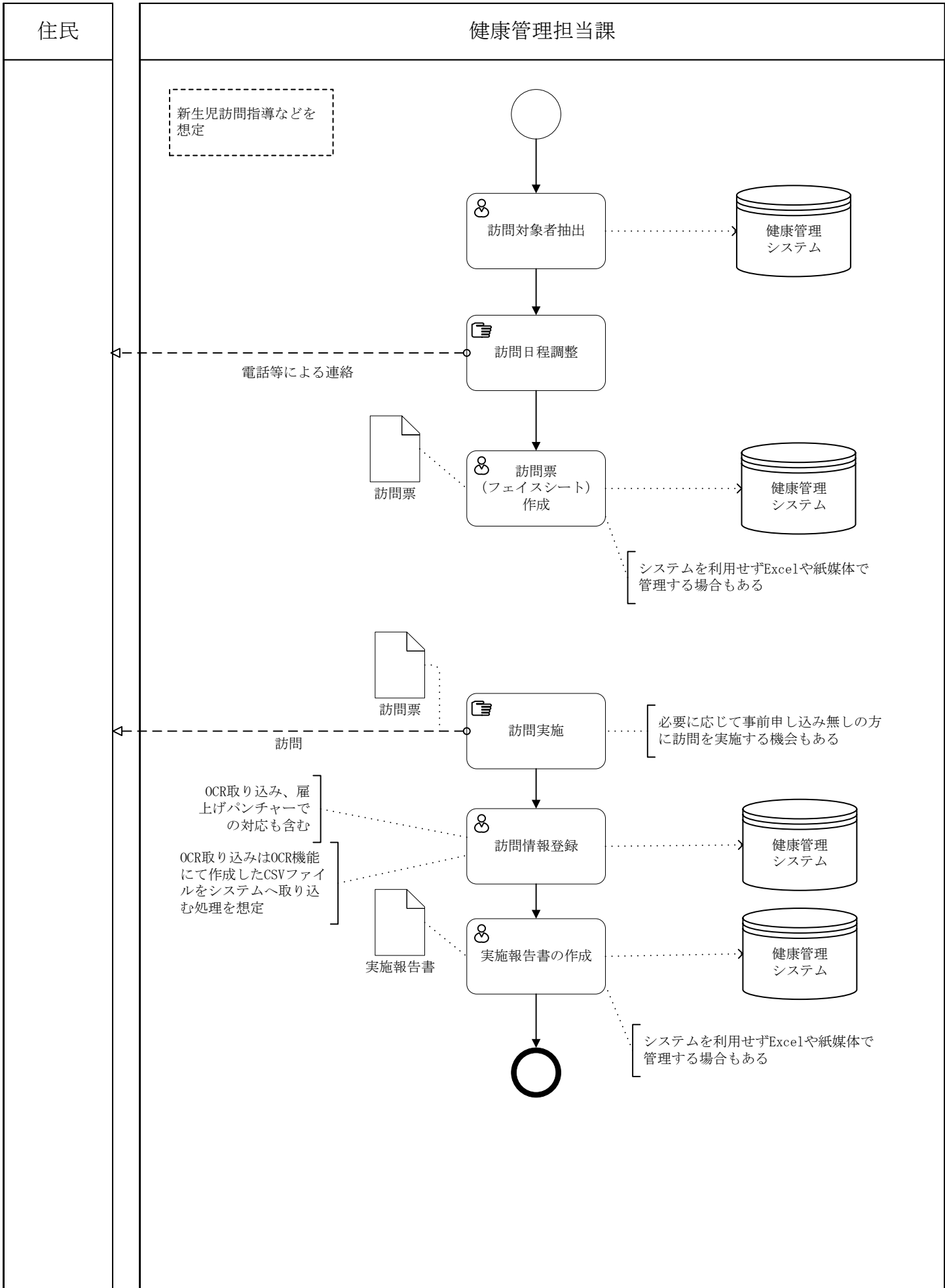

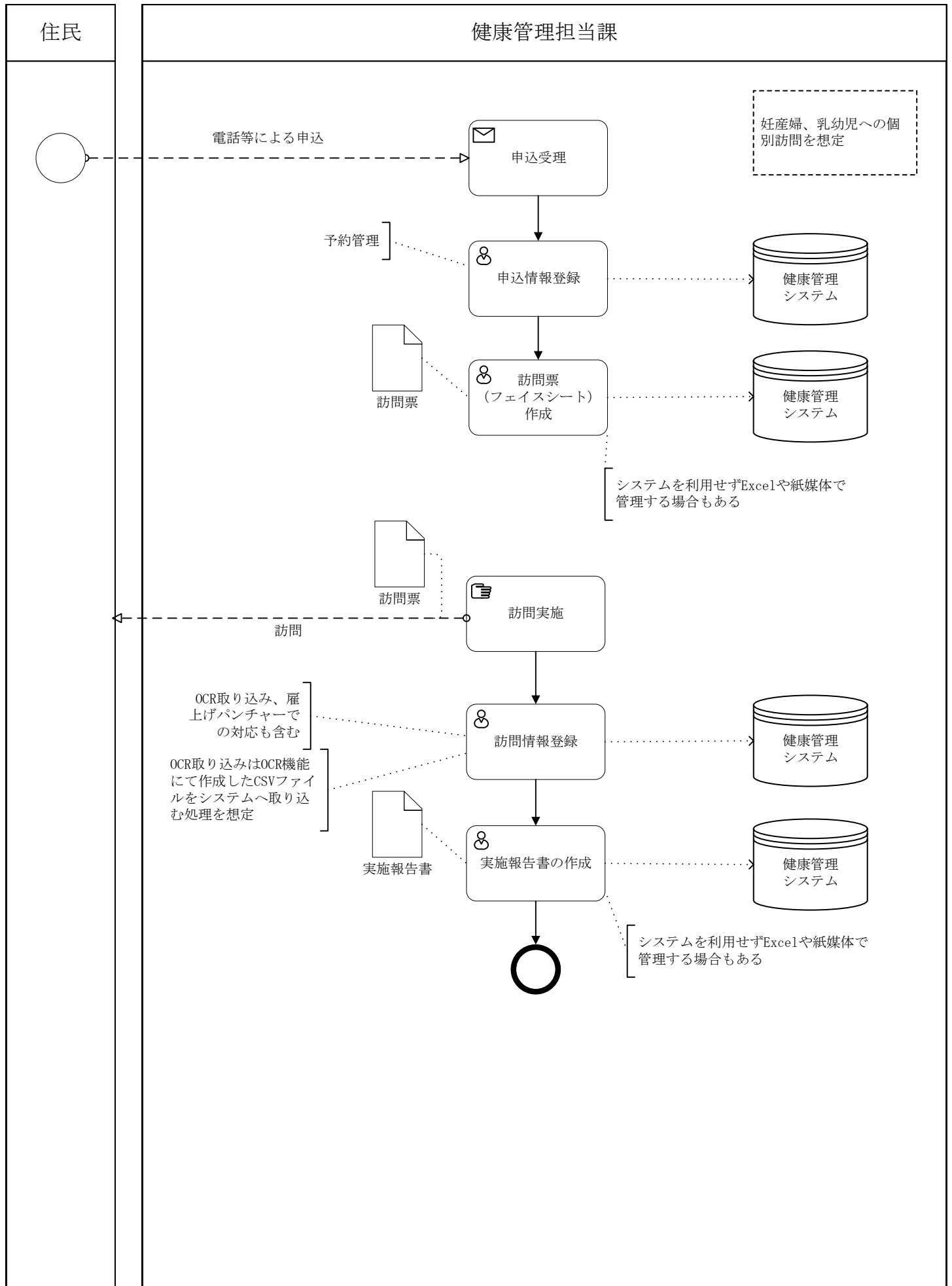

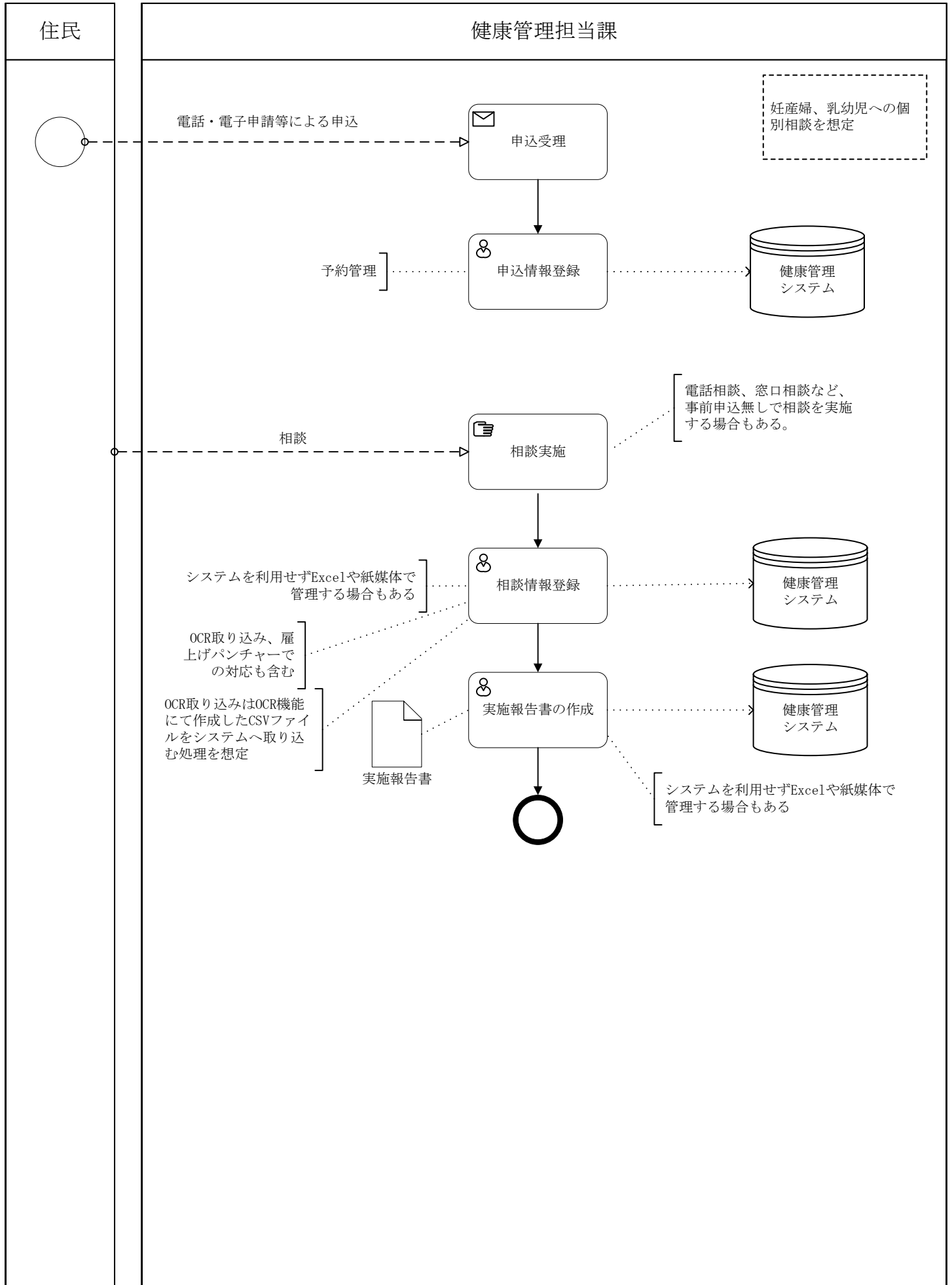

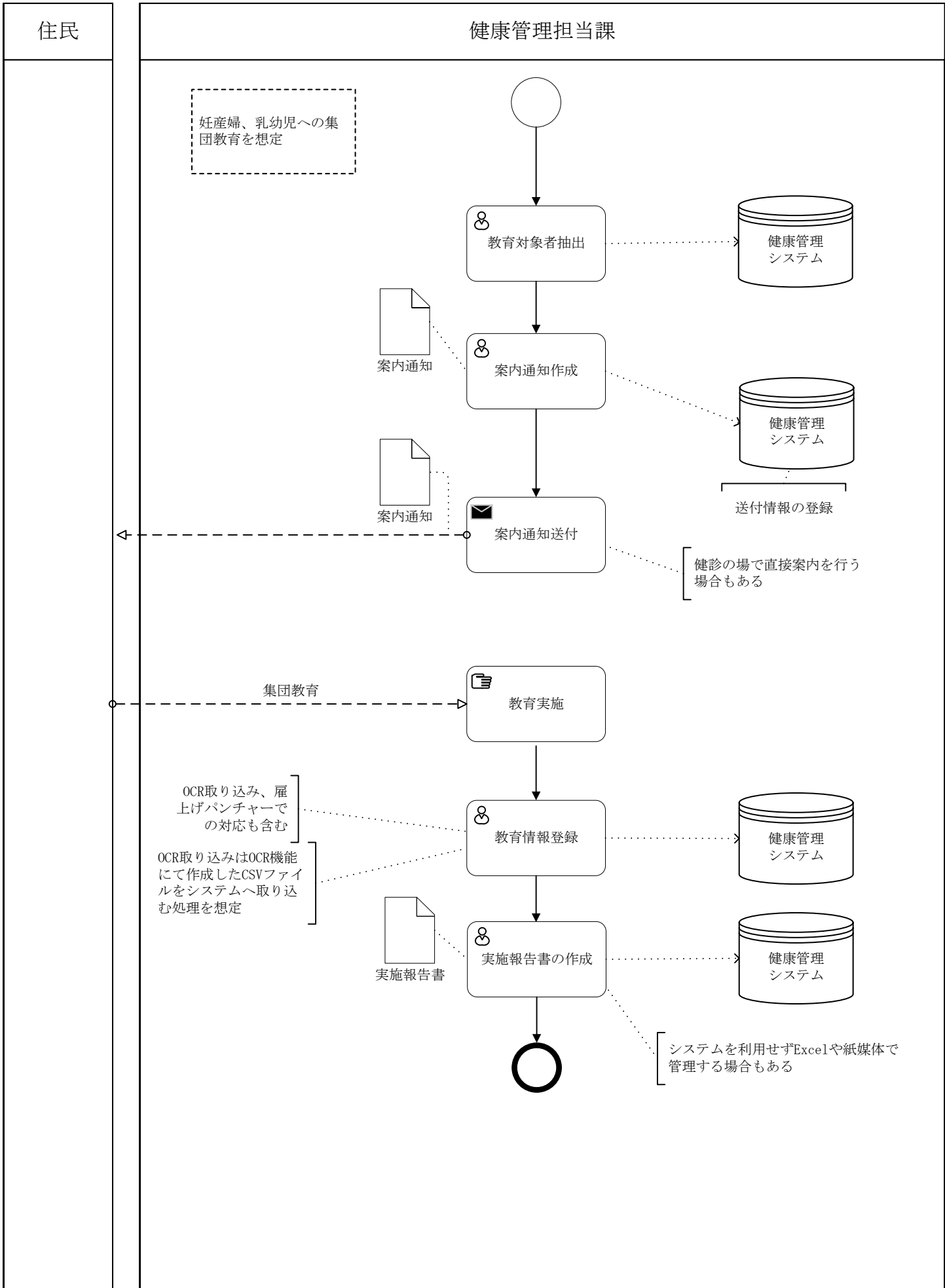

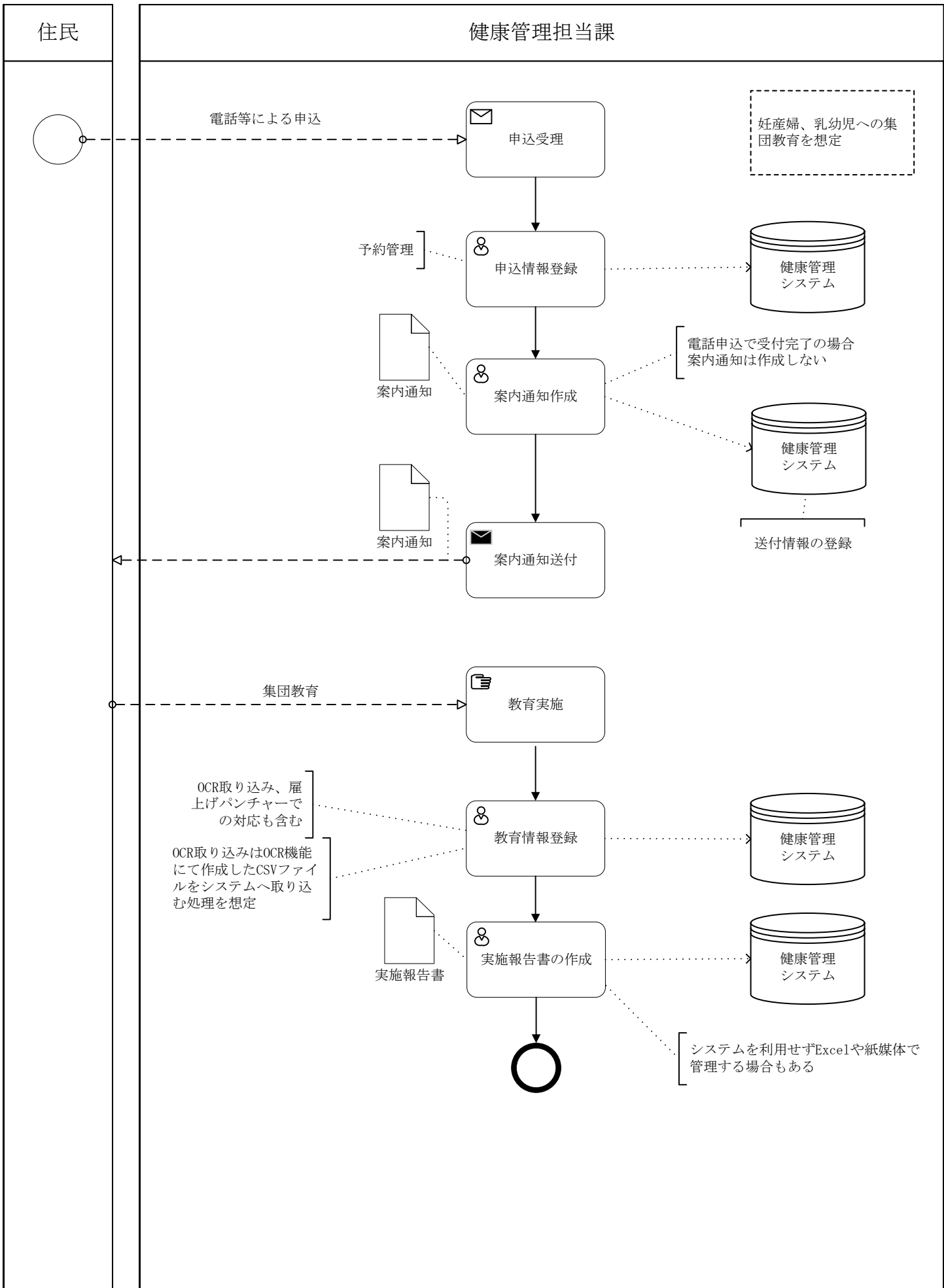

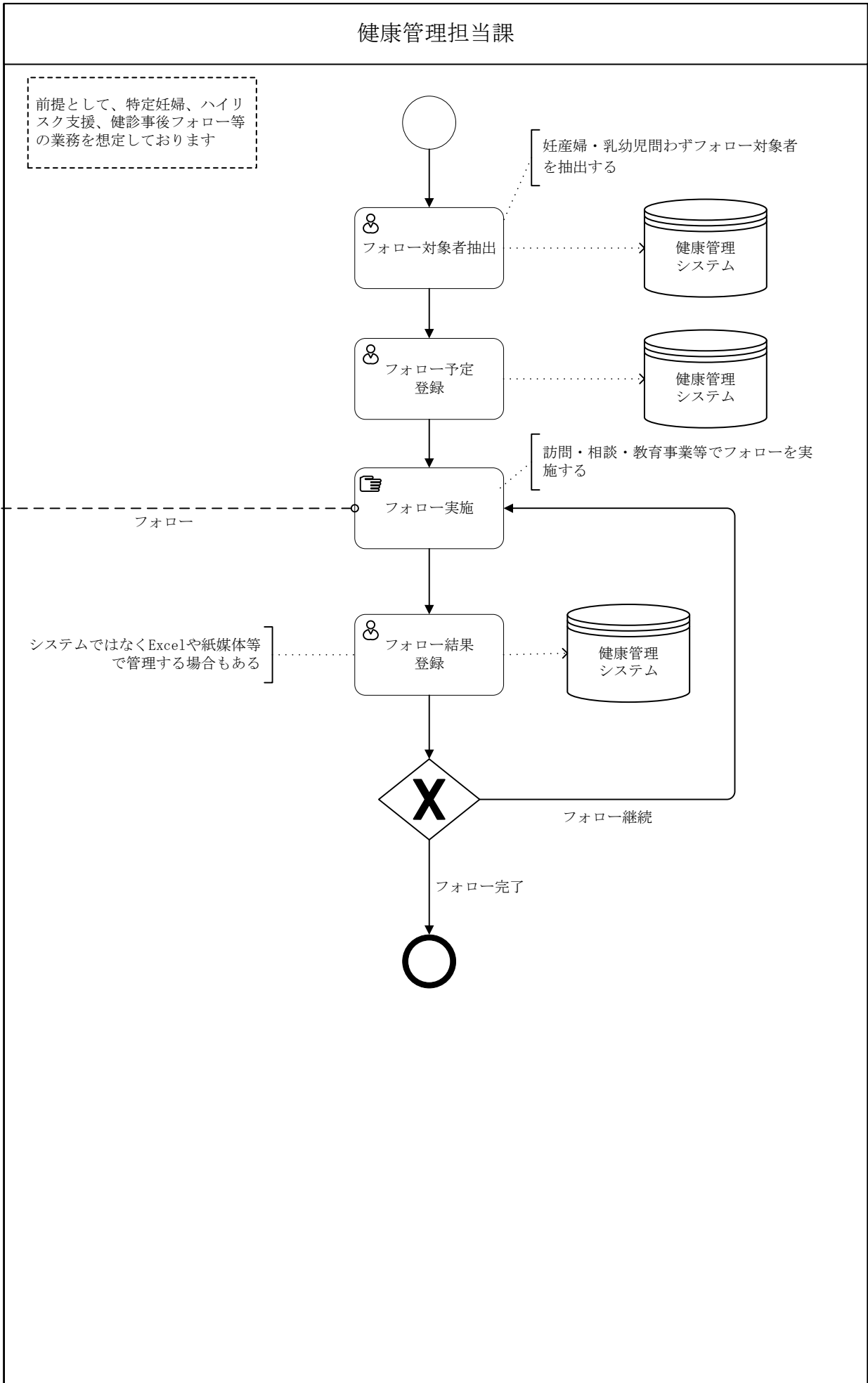

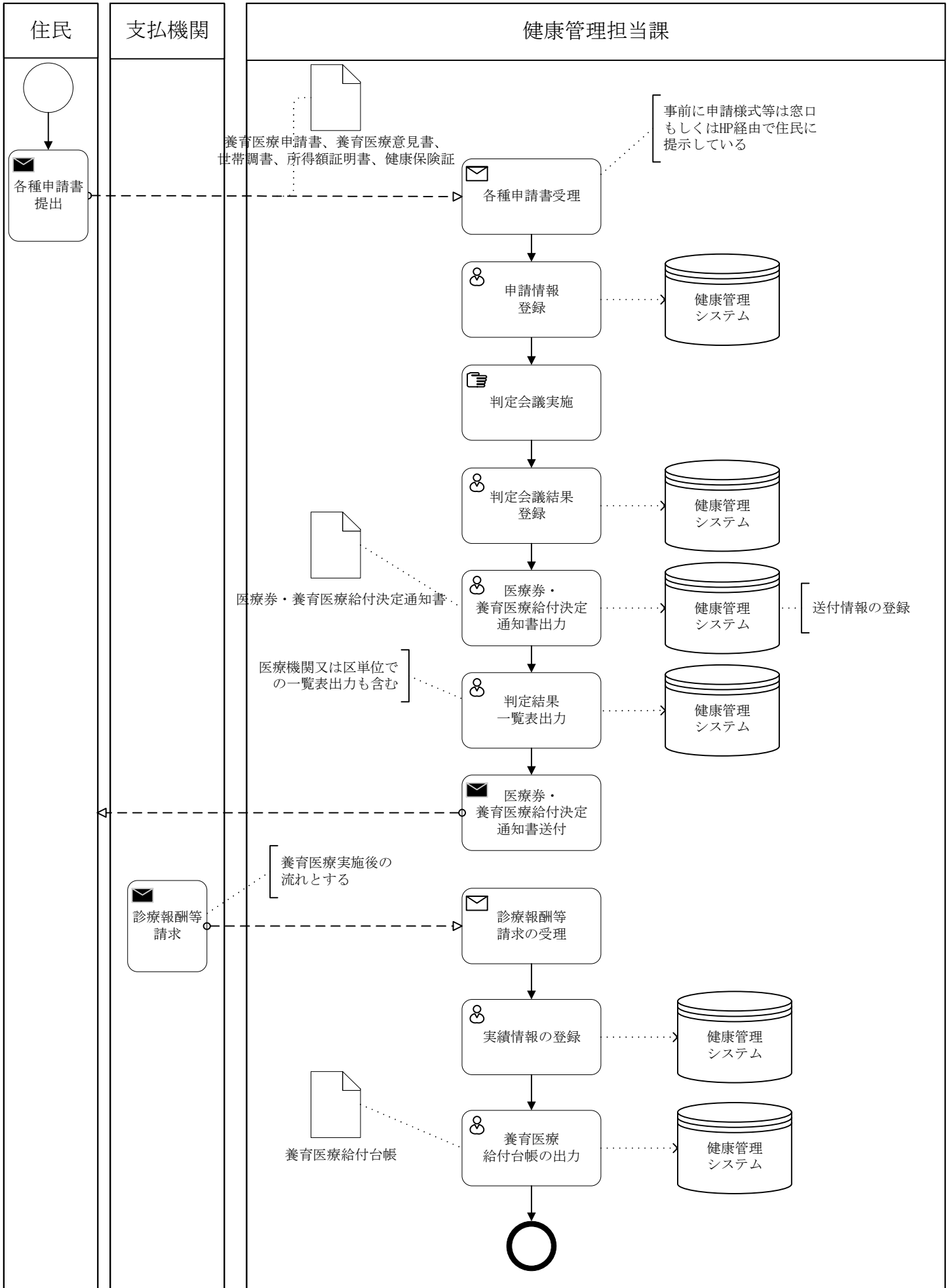

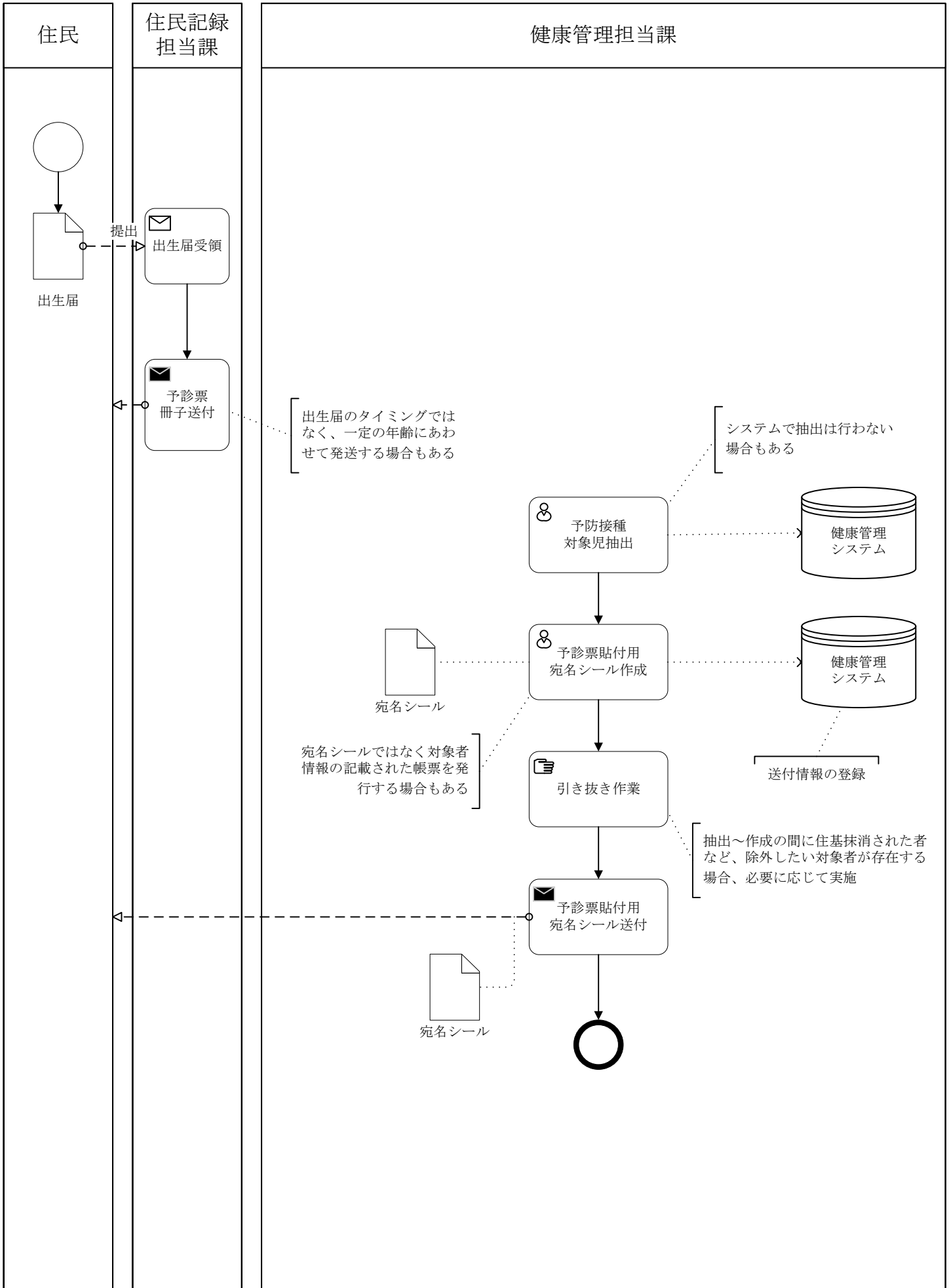

住民

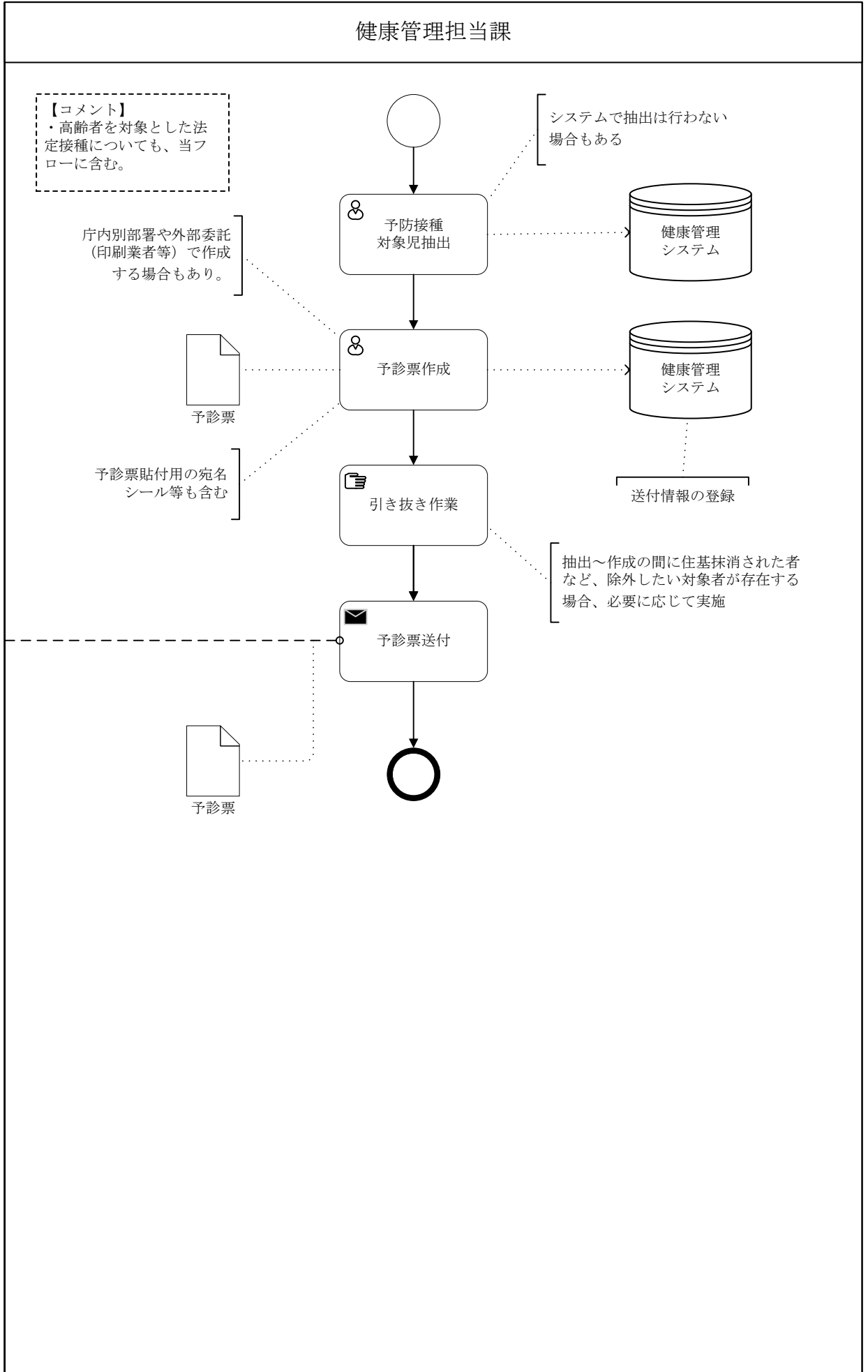

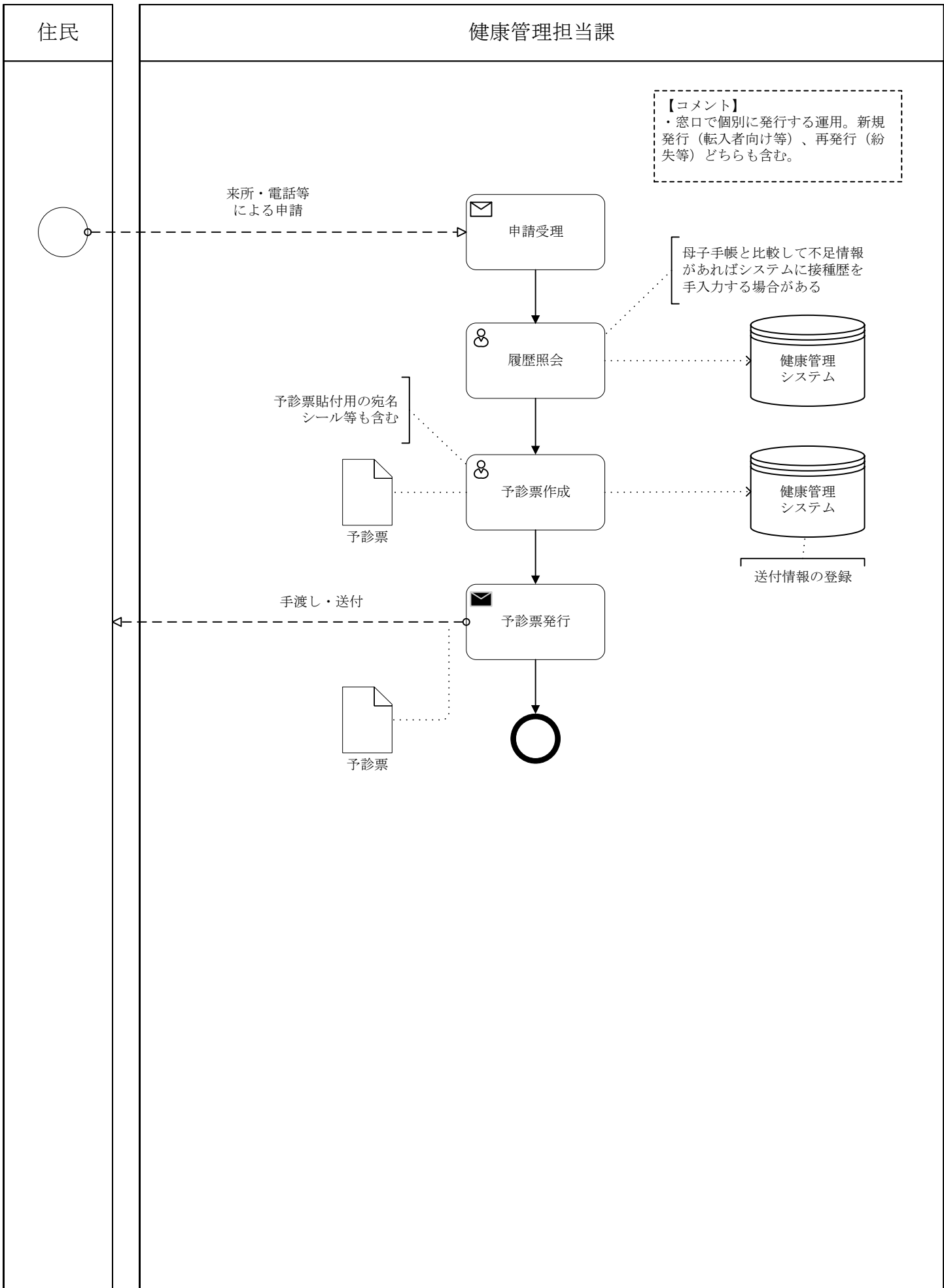

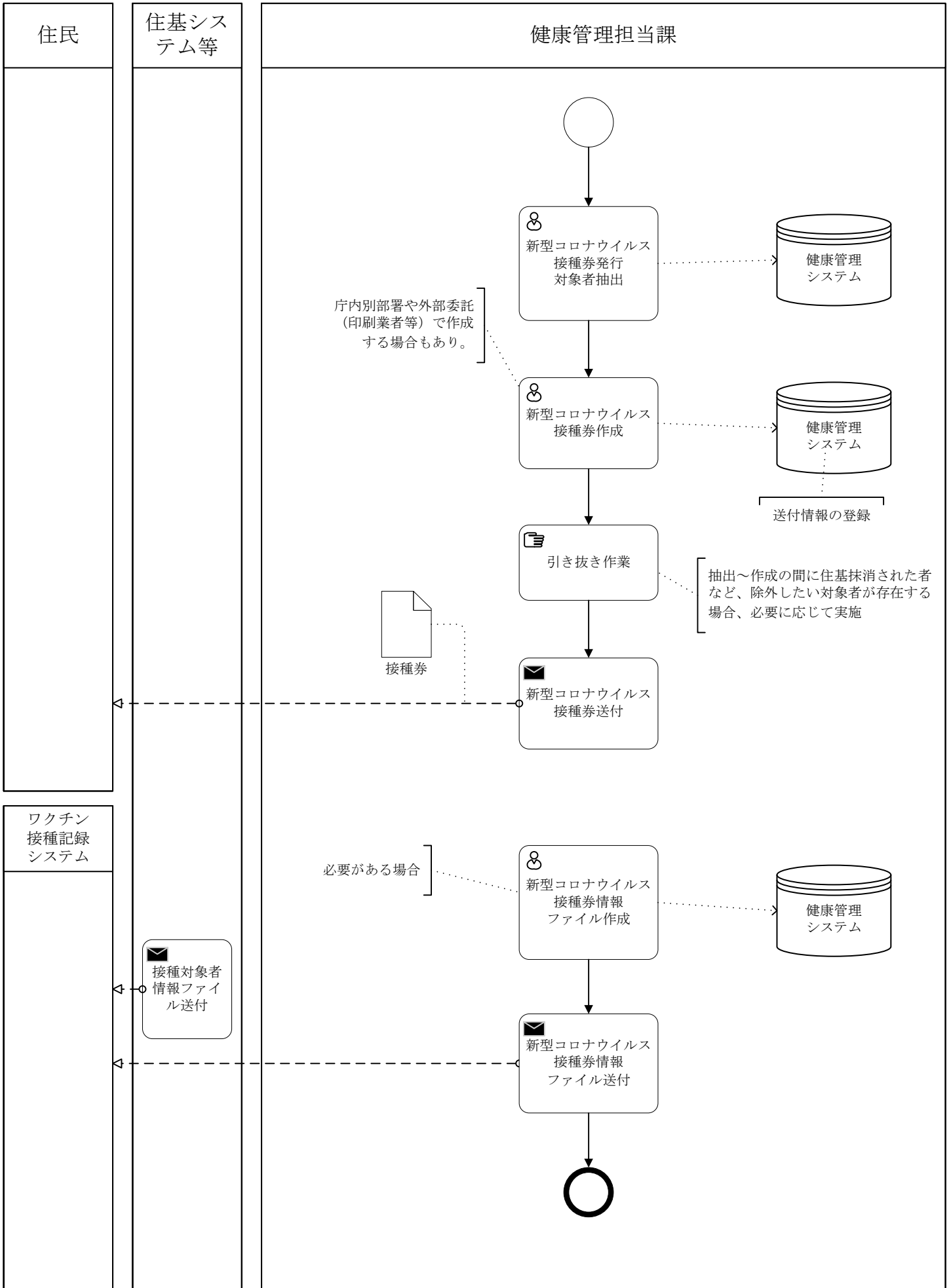

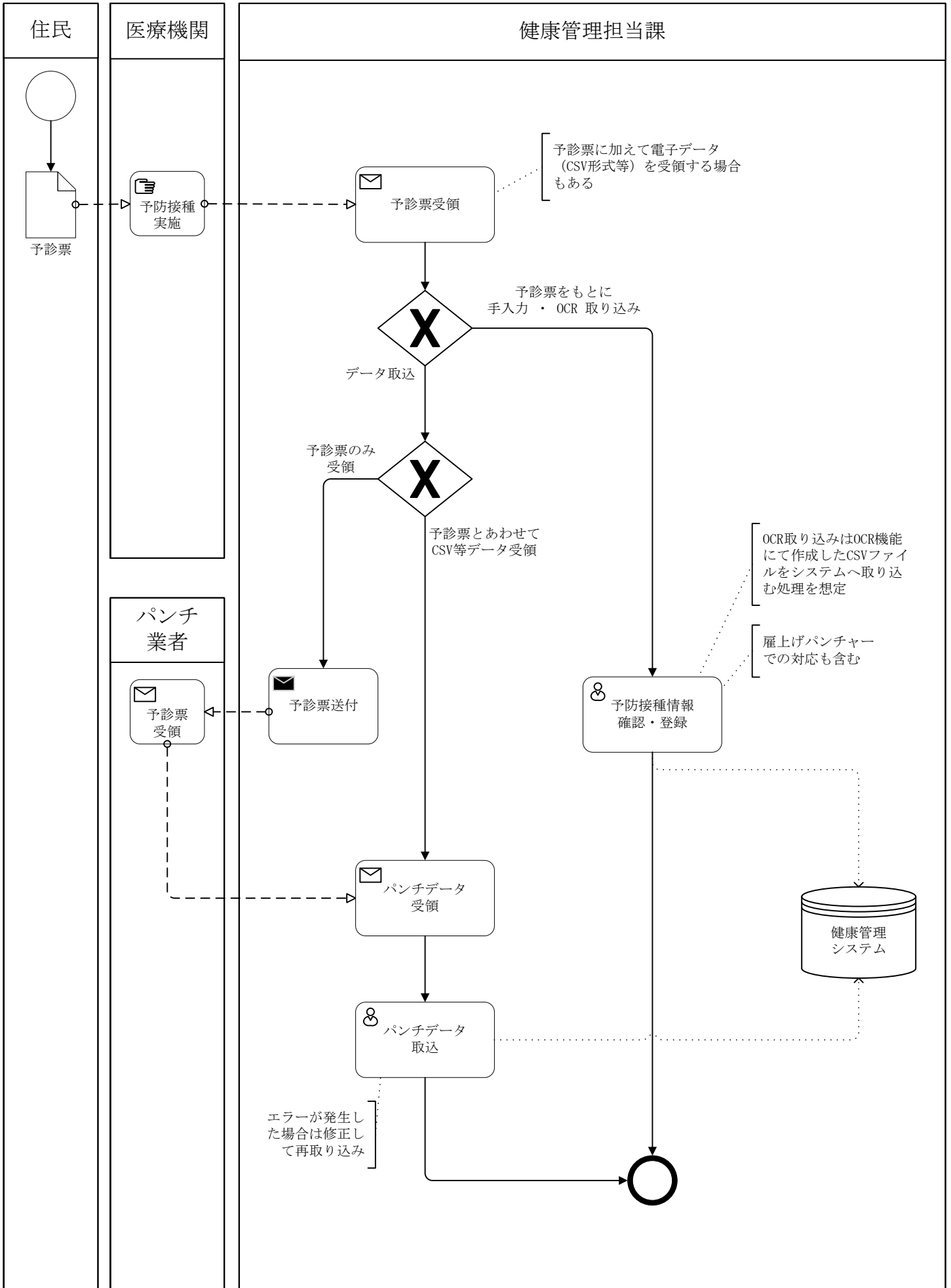

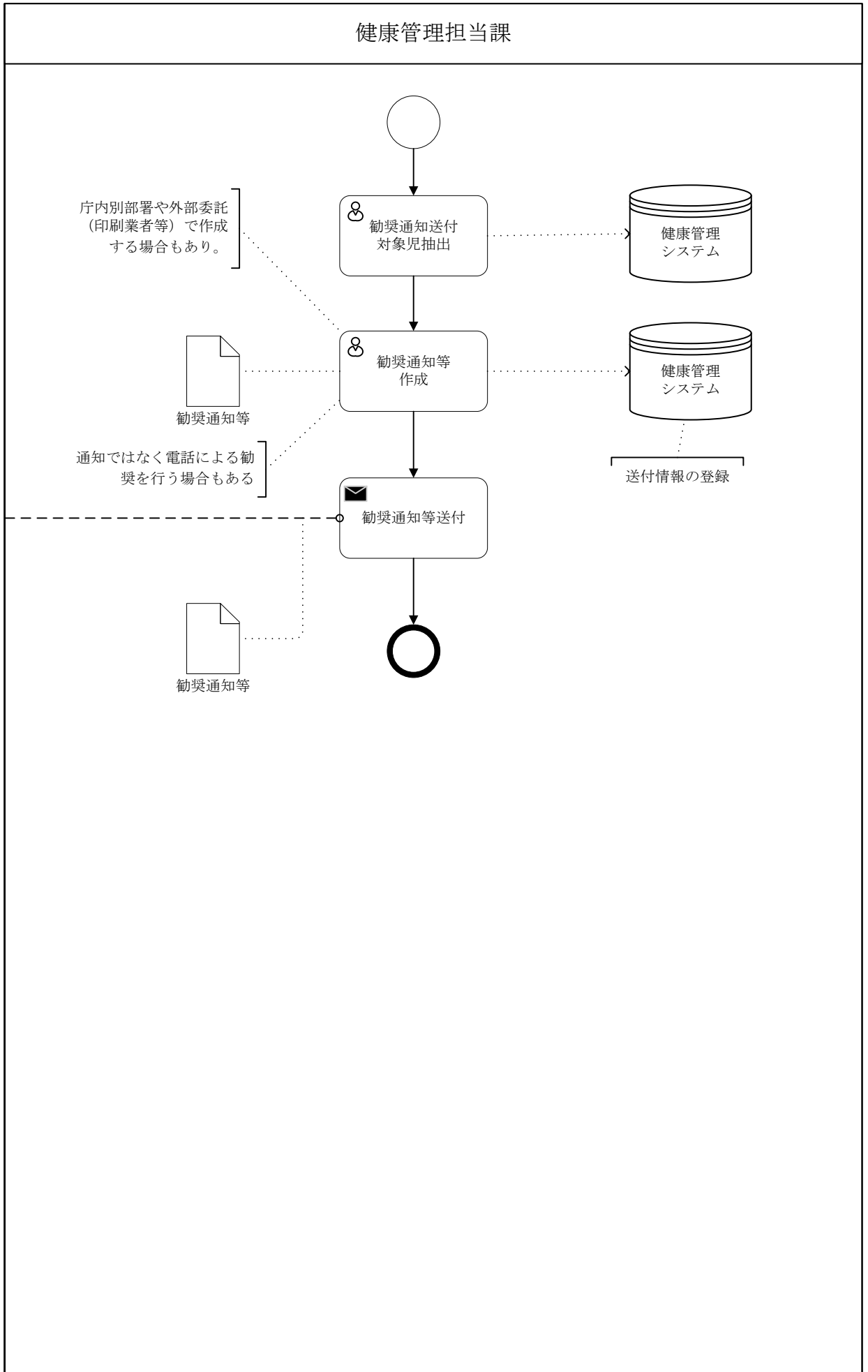
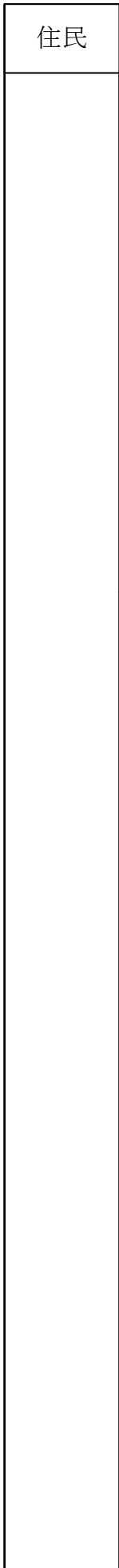

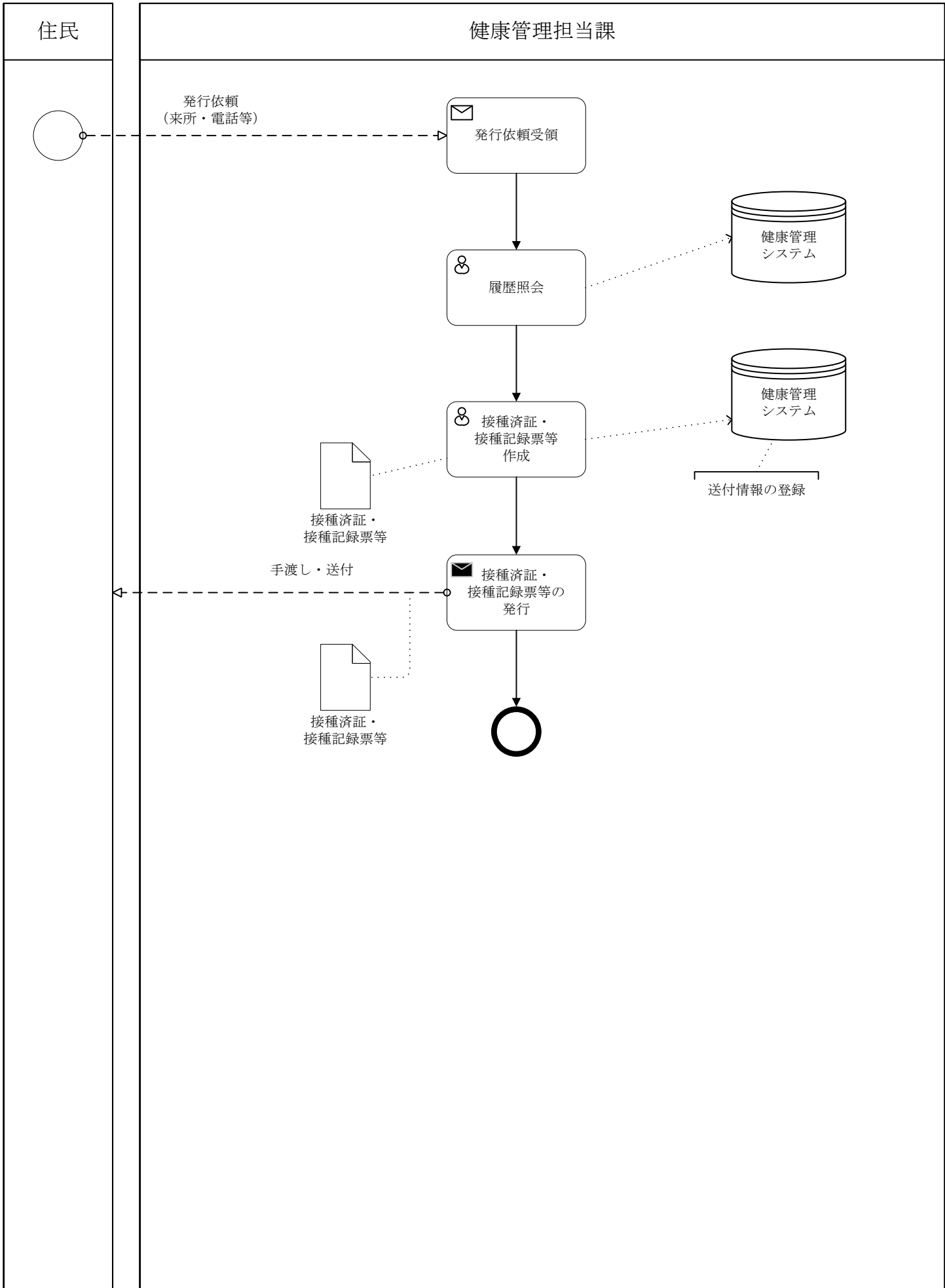

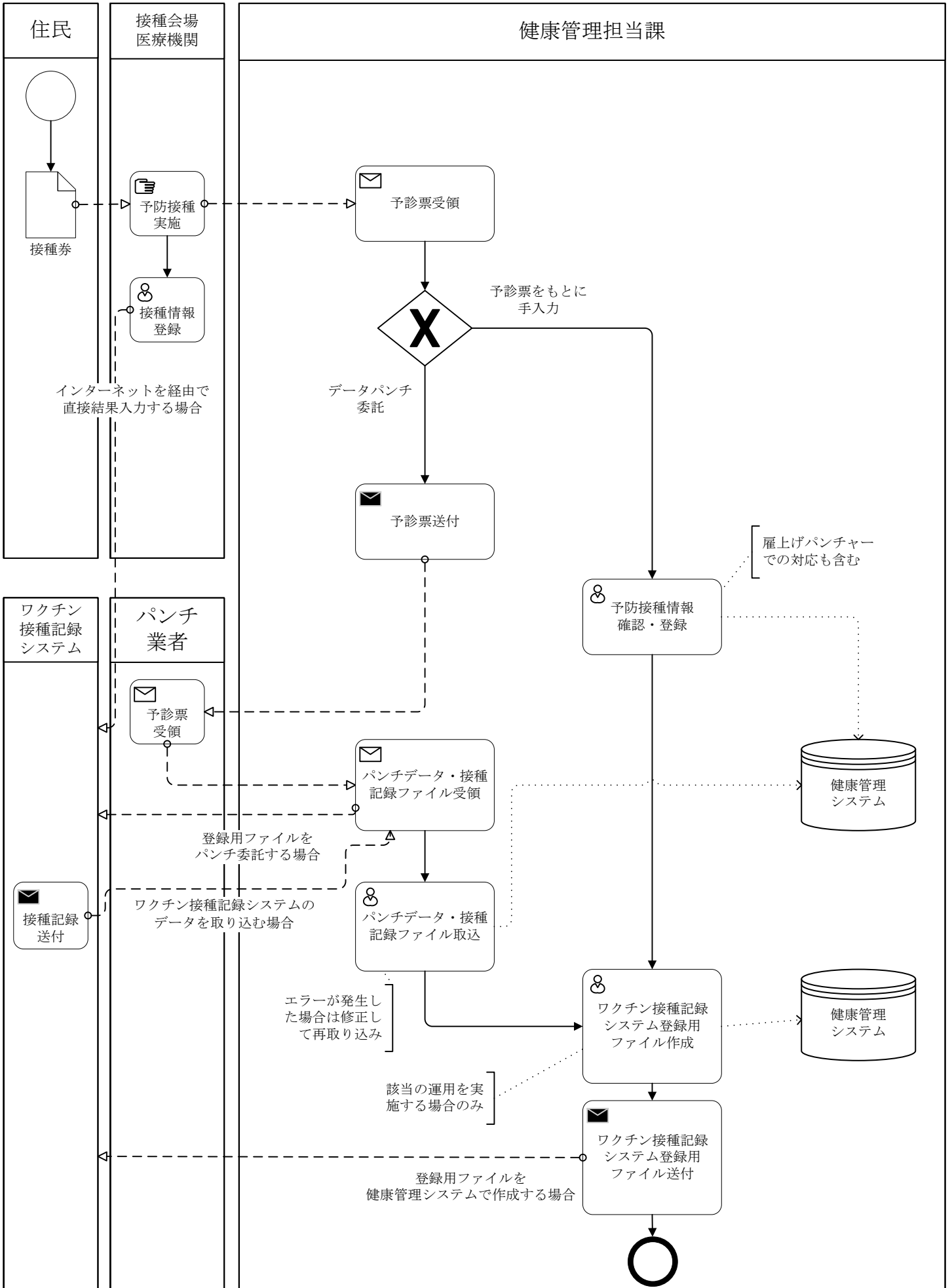

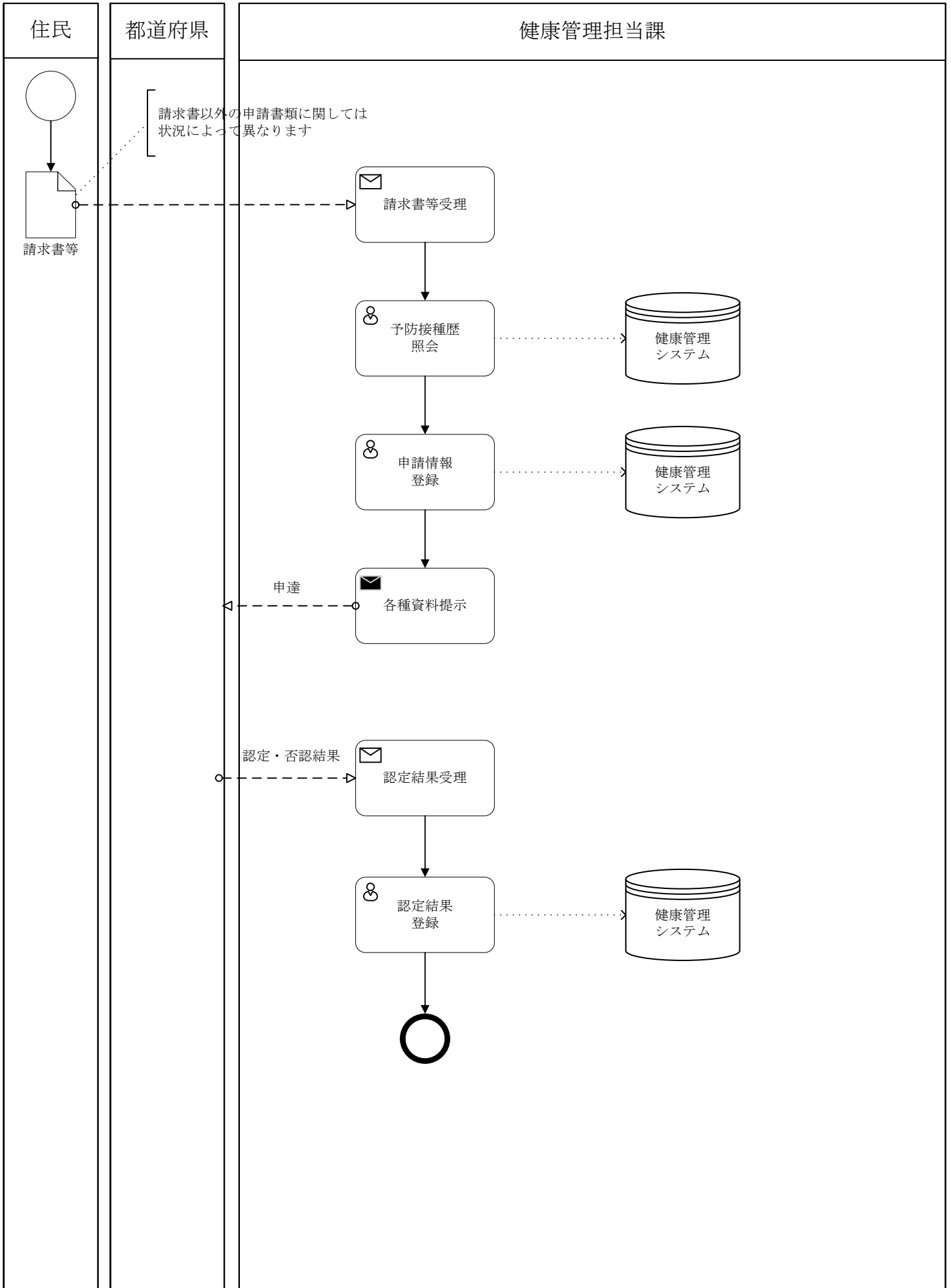

関係機関

