







## 業務フロー

## BPMN凡例

記号	意味
	開始イベント (業務フローの開始)
	終了イベント (業務フローの終了)
	結合子 (ページが跨る場合の前ページ記号)
	結合子 (ページが跨る場合の次ページ記号)
	タスク (書類の受領)
	タスク (書類の送付)
	タスク (手作業)
	タスク (システム操作)
	書類(システム出力帳票・システム出力外帳票)、電子データファイル

記号	意味
	システムデータベース
	条件分岐
	並列処理
	正常運用の流れ
	部門等を跨ぐ流れ
	補足説明

**業務フロー一覧**

区分	大分類	小分類	頁番号
人口動態調査事務	1. 一般	1. 1. 調査票作成(出生、死亡、婚姻、離婚)	3
		1. 2. 調査票作成(死産)	4
		1. 3. 調査票出力	5
		1. 4. 送付票出力	6
		1. 5. 事件簿出力	7
		1. 6. 受理証明書の交付(死産)	8

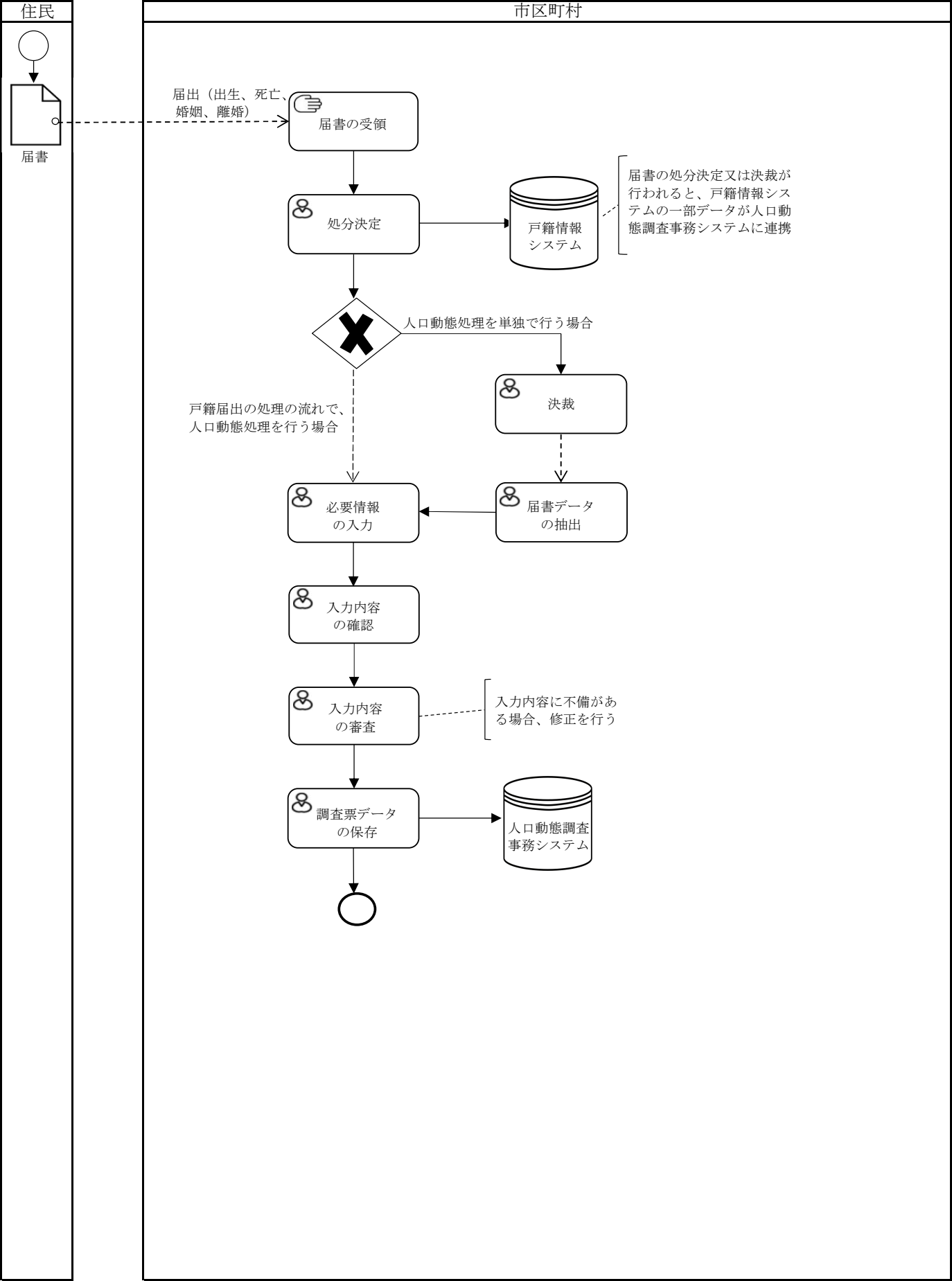

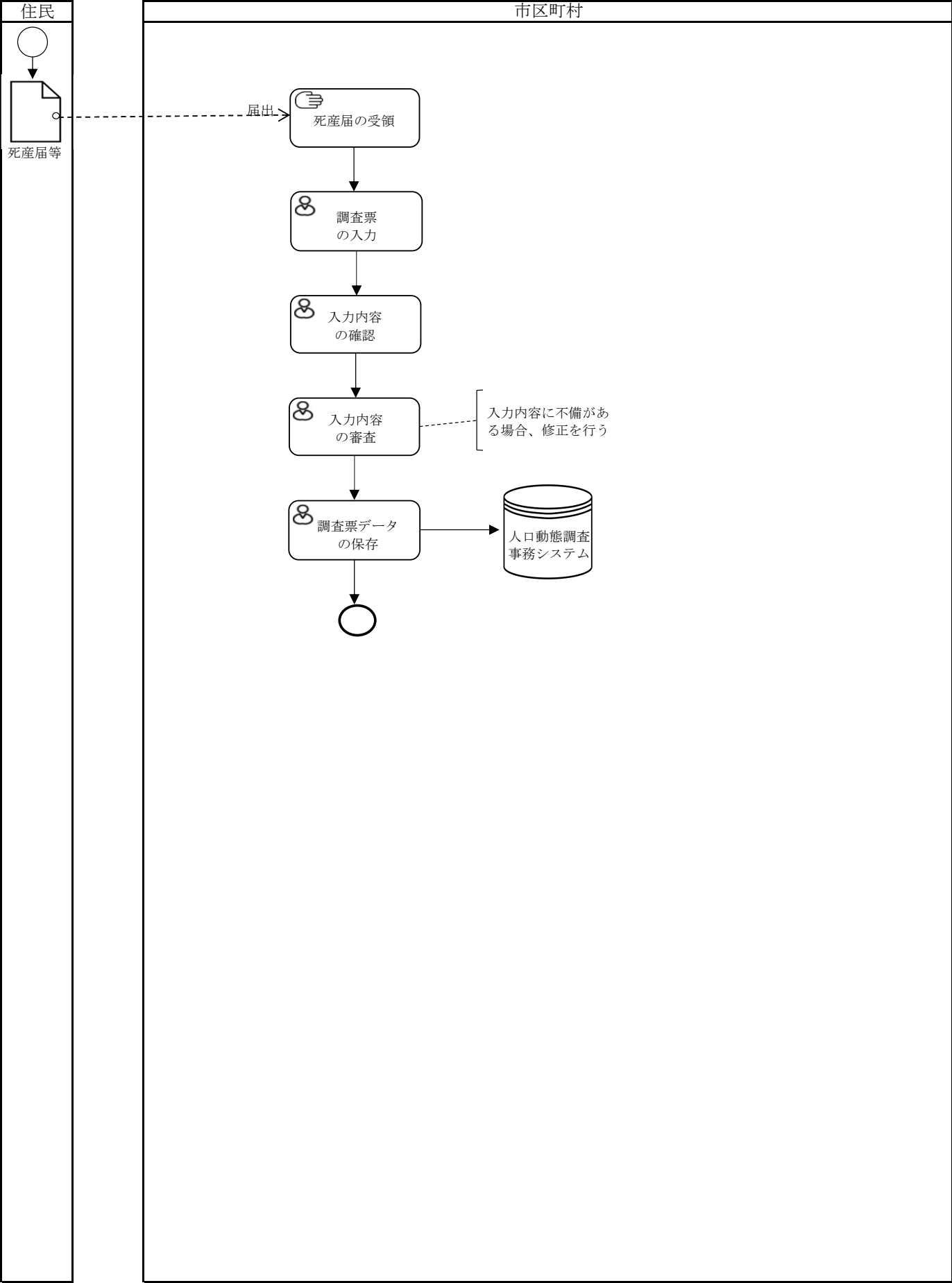

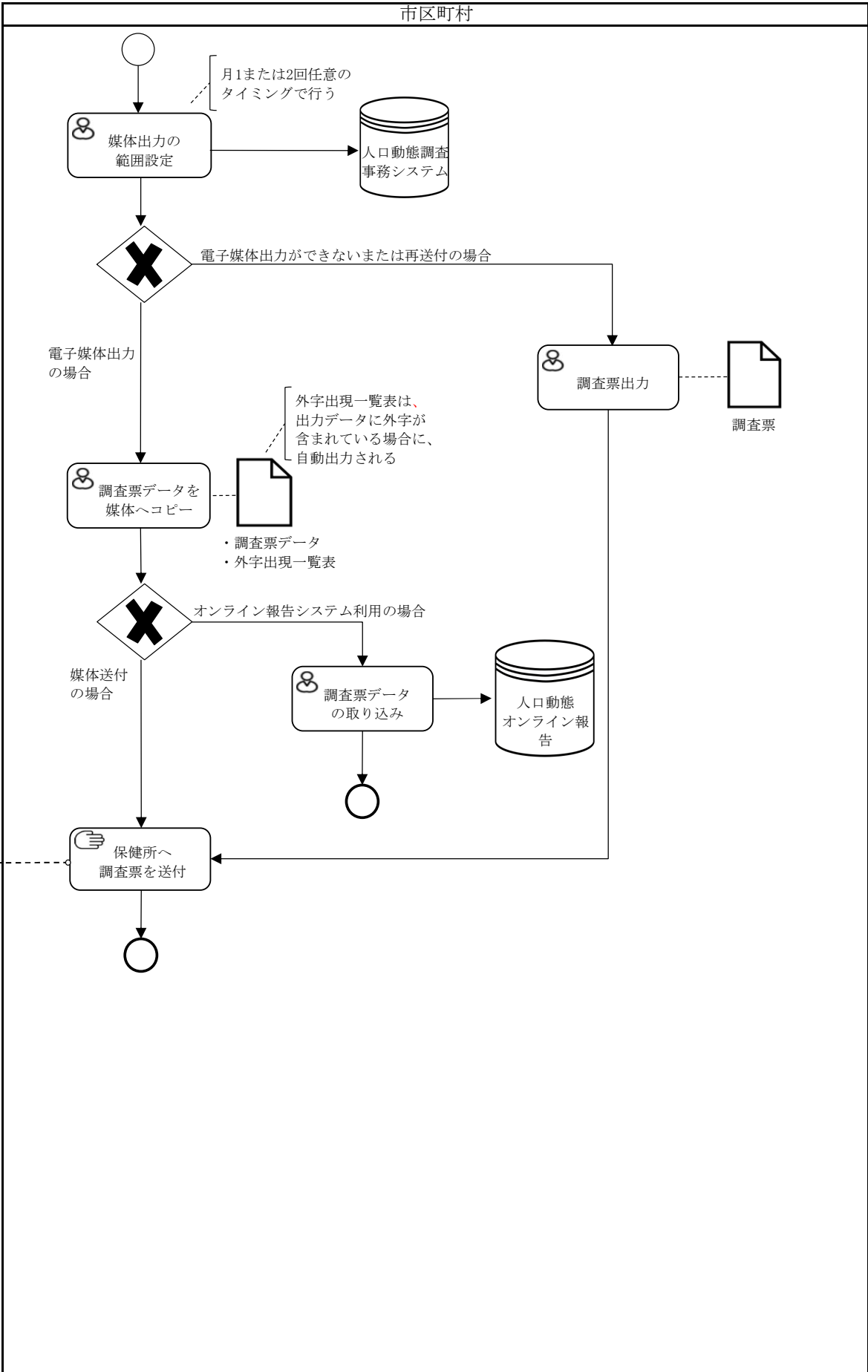

住民

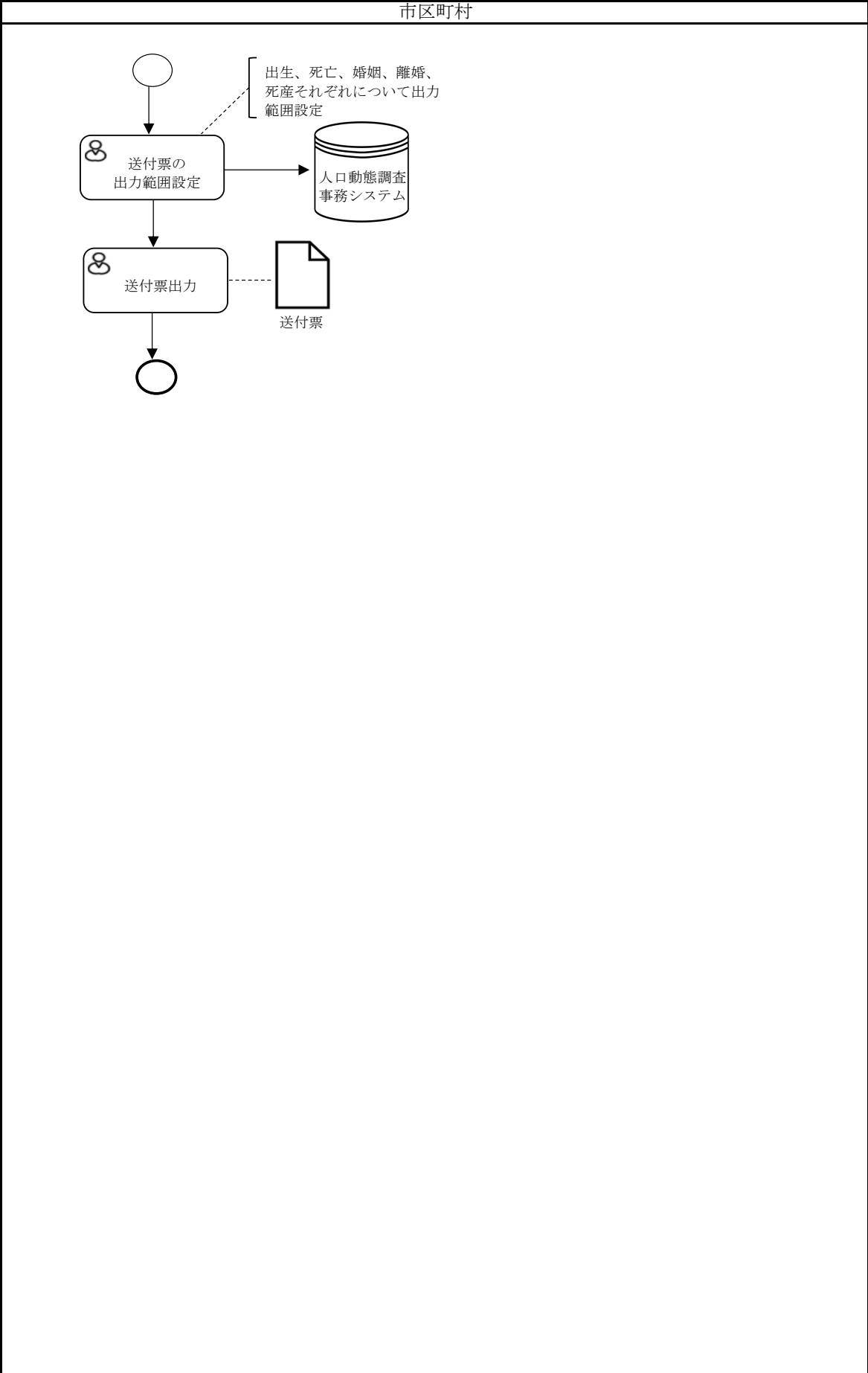

住民

