

060190 虚血性腸炎

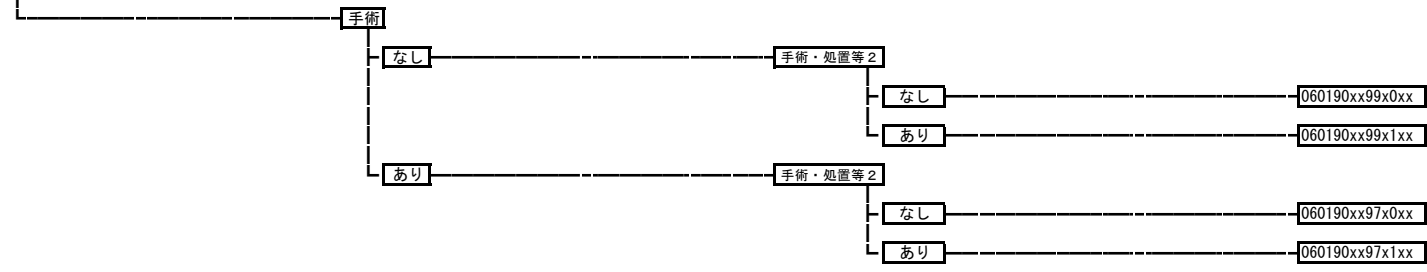

060200 腸重積

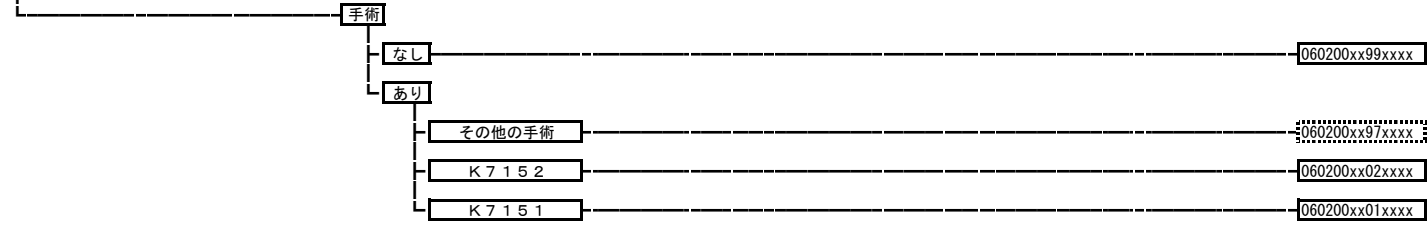

060210 ヘルニアの記載のない腸閉塞

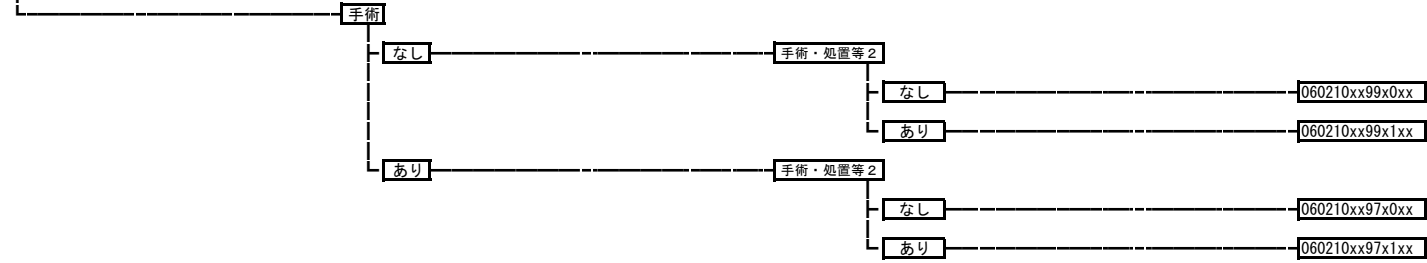

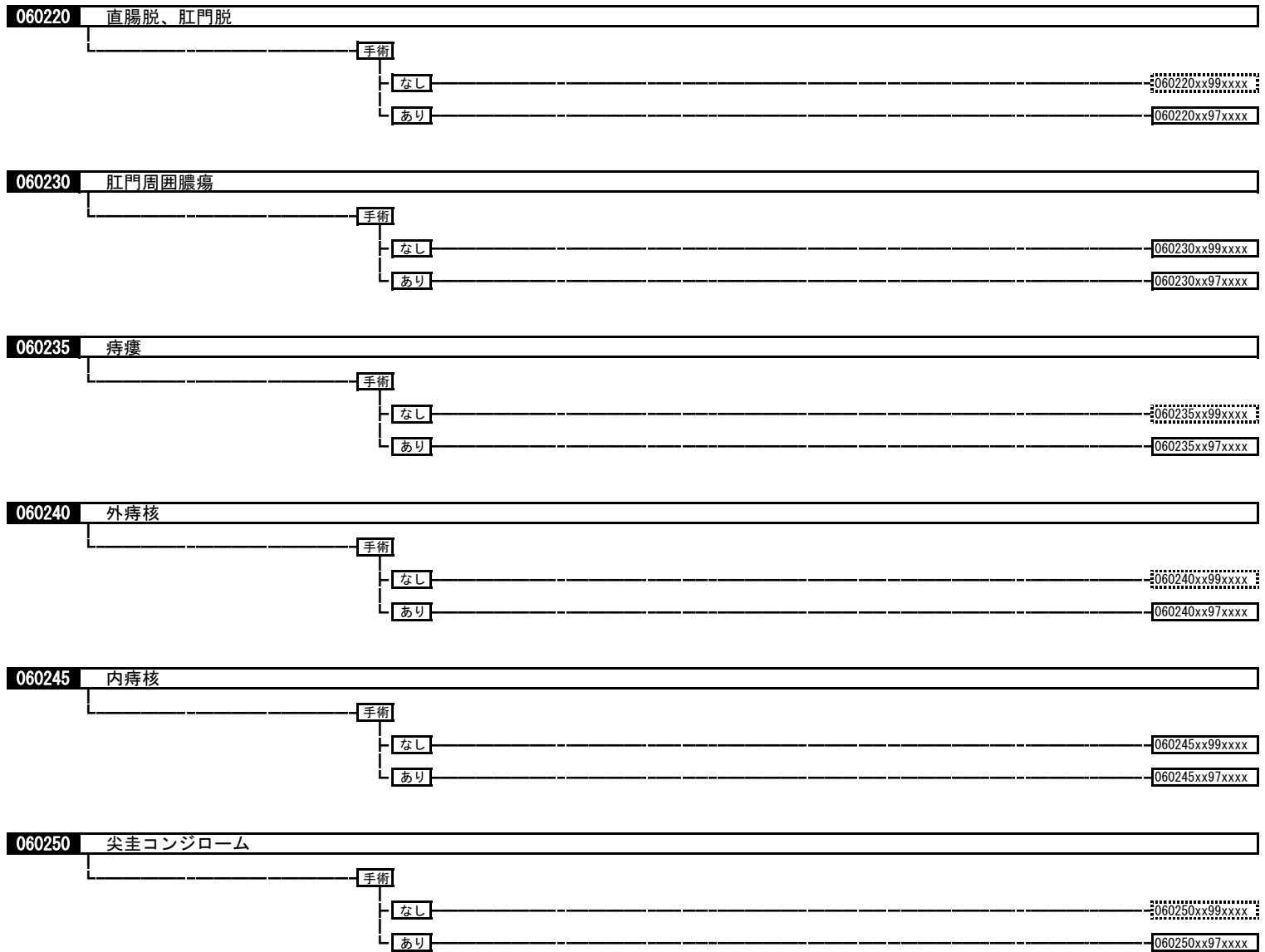

060260 肛門狭窄、肛門裂溝

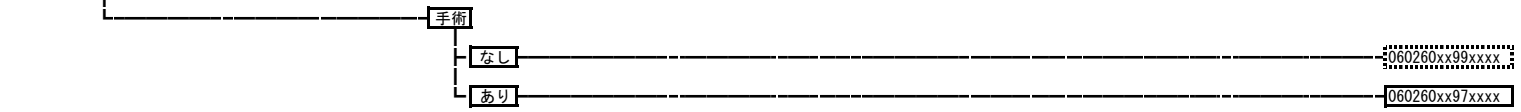

060270 劇症肝炎、急性肝不全、急性肝炎

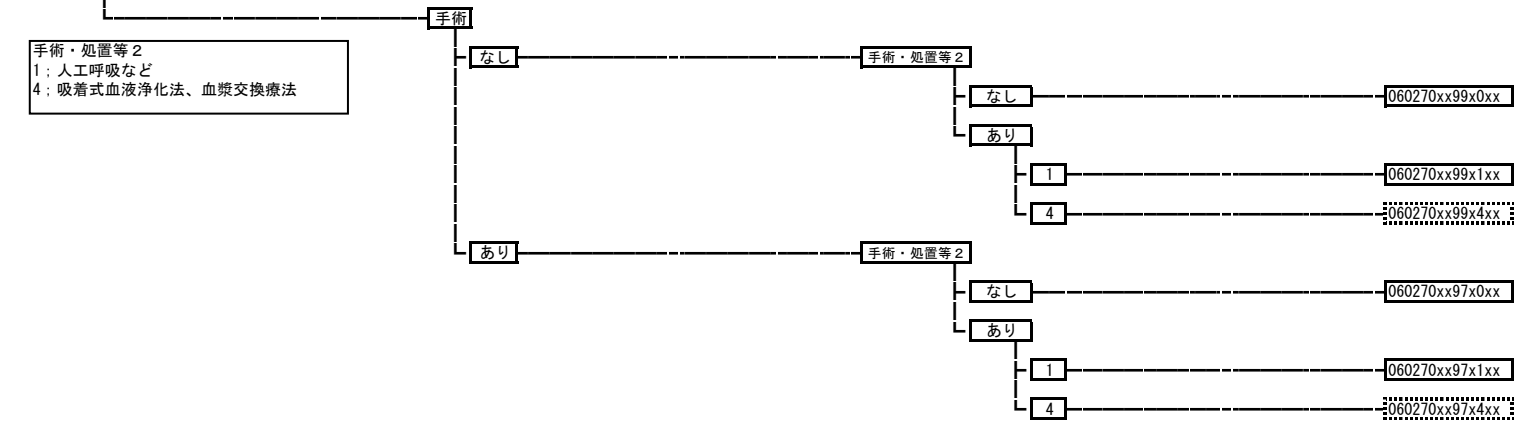

060280 アルコール性肝障害

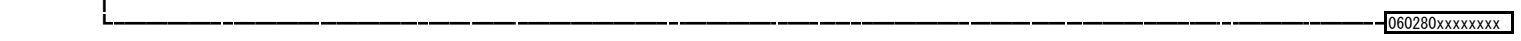

060290 慢性肝炎（慢性C型肝炎を除く。）

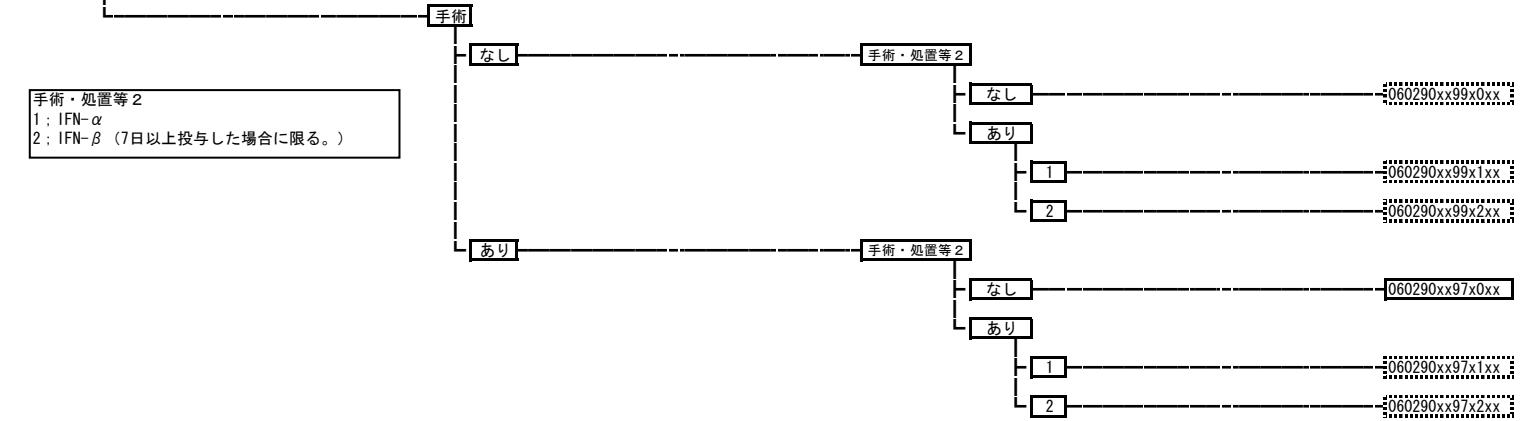

060295 慢性C型肝炎

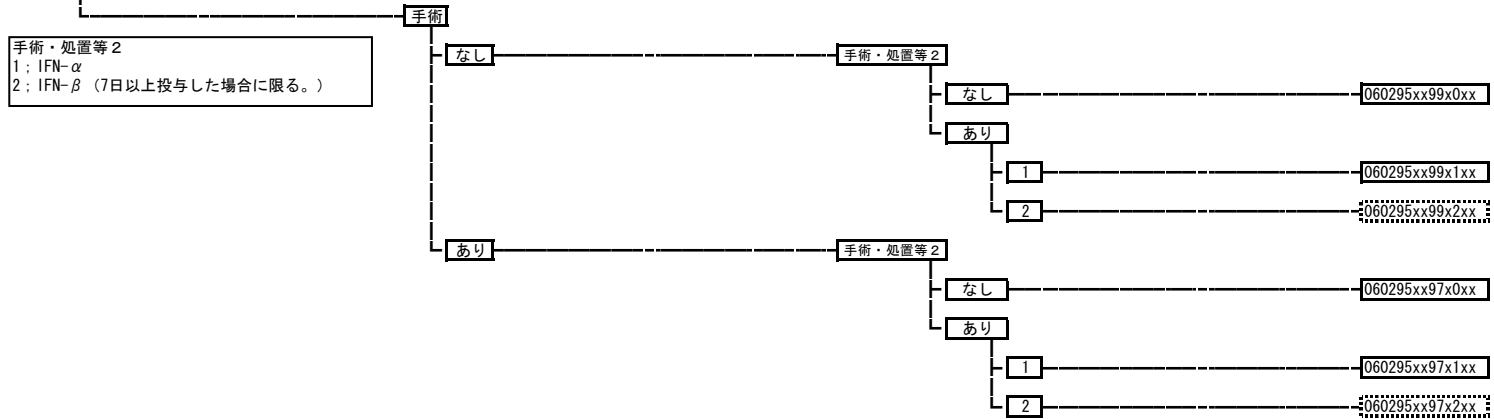

060300 肝硬変 (胆汁性肝硬変を含む。)

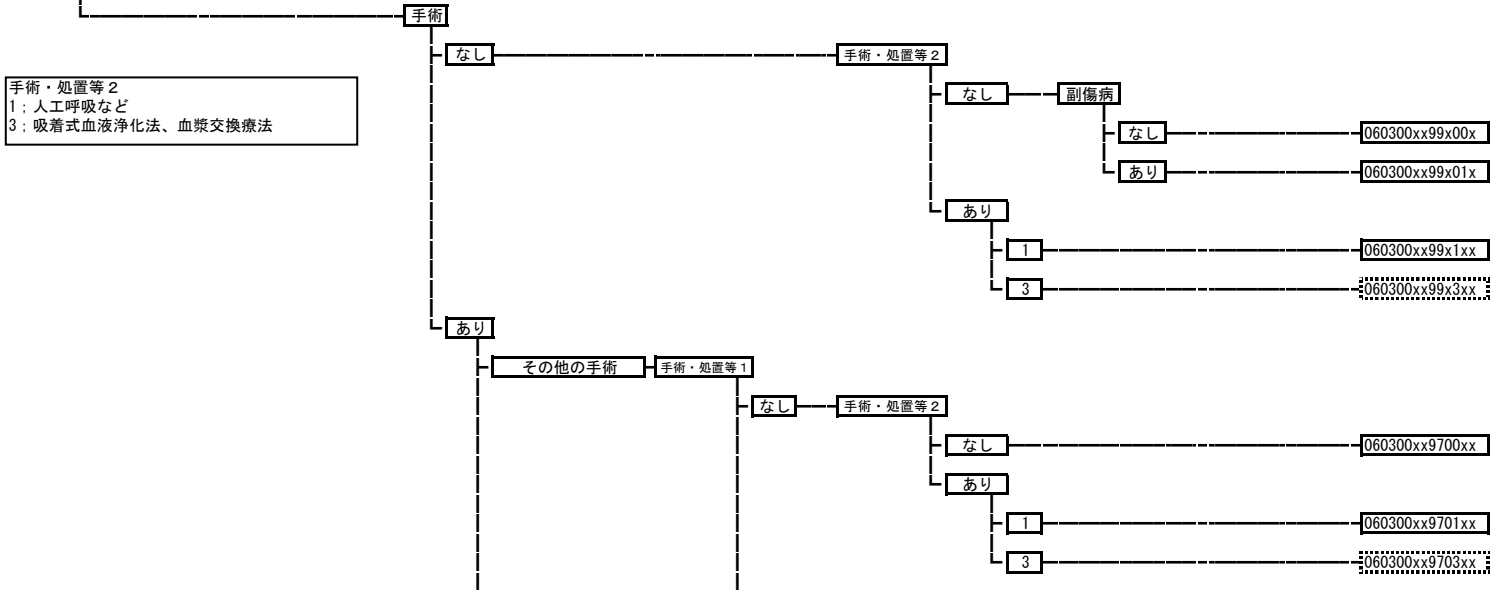

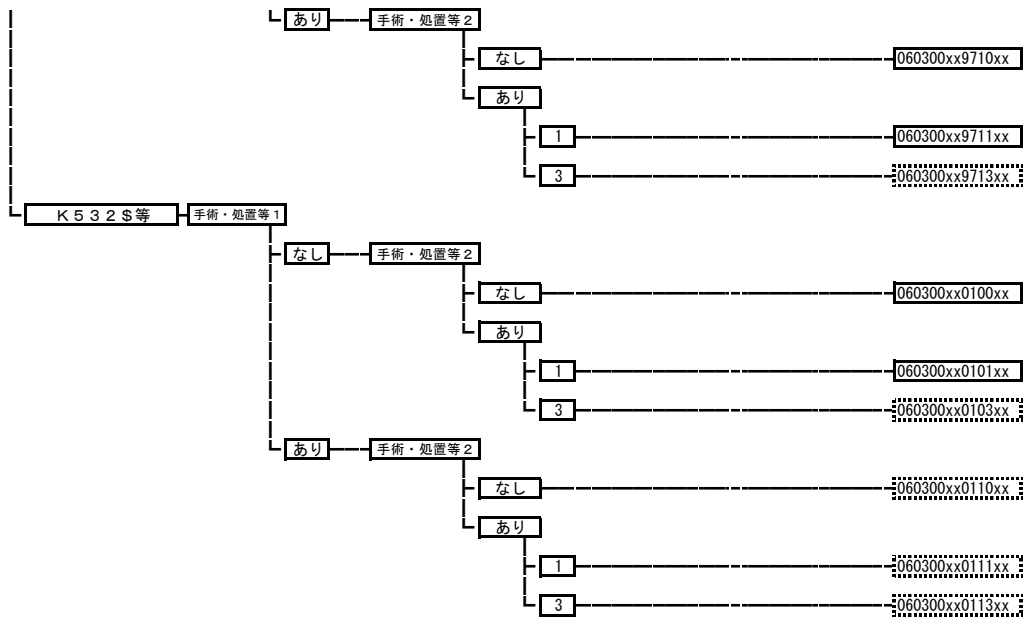

060310 肝膿瘍（細菌性・寄生虫性疾患を含む。）

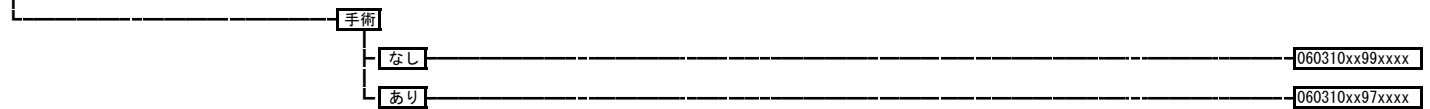

060320 肝嚢胞

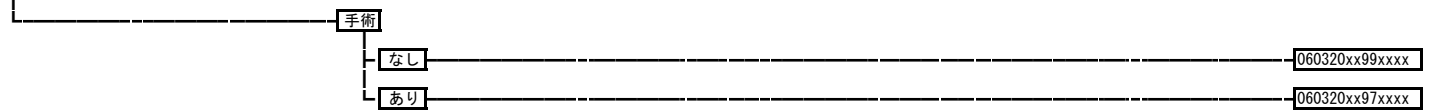

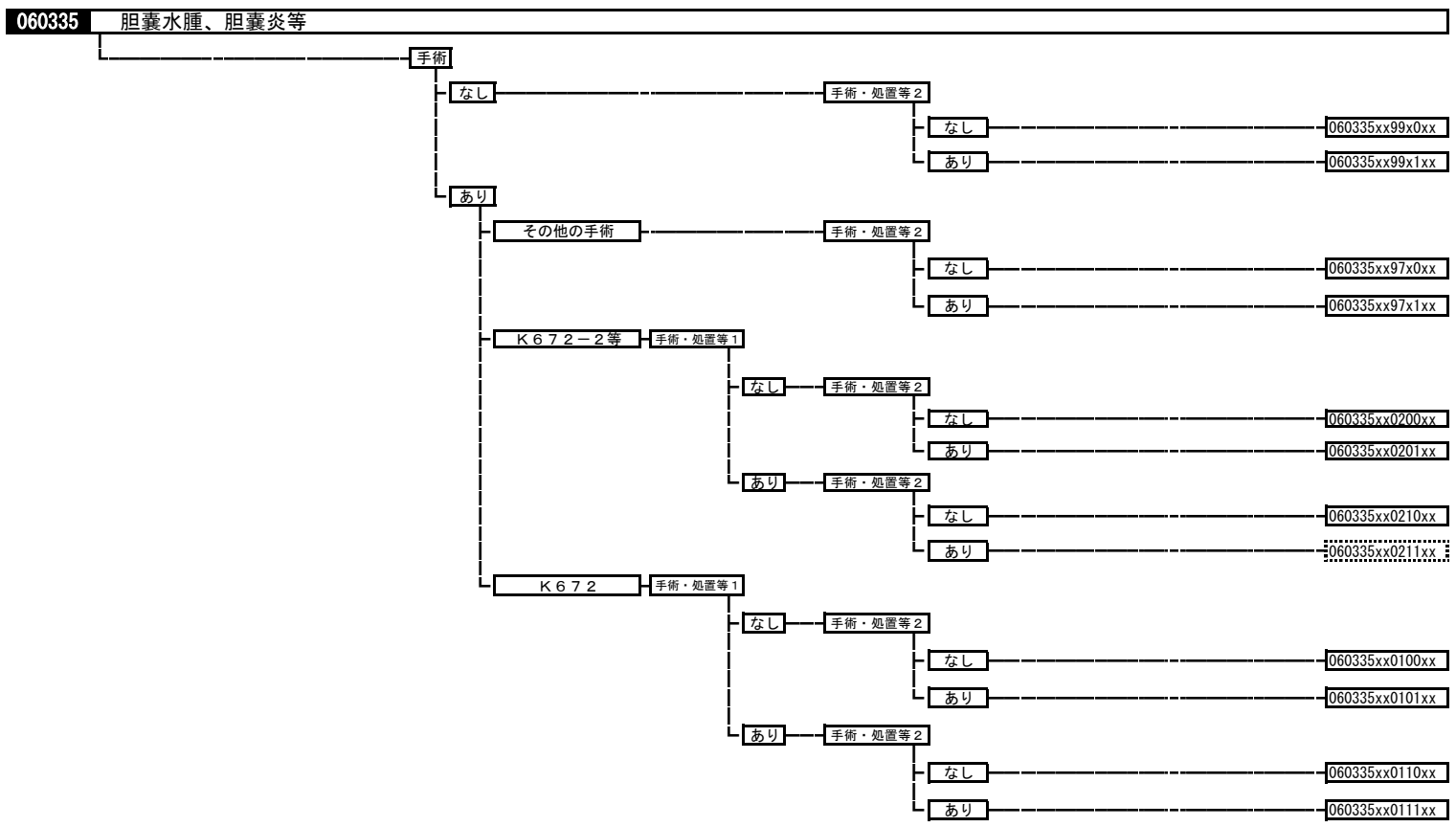
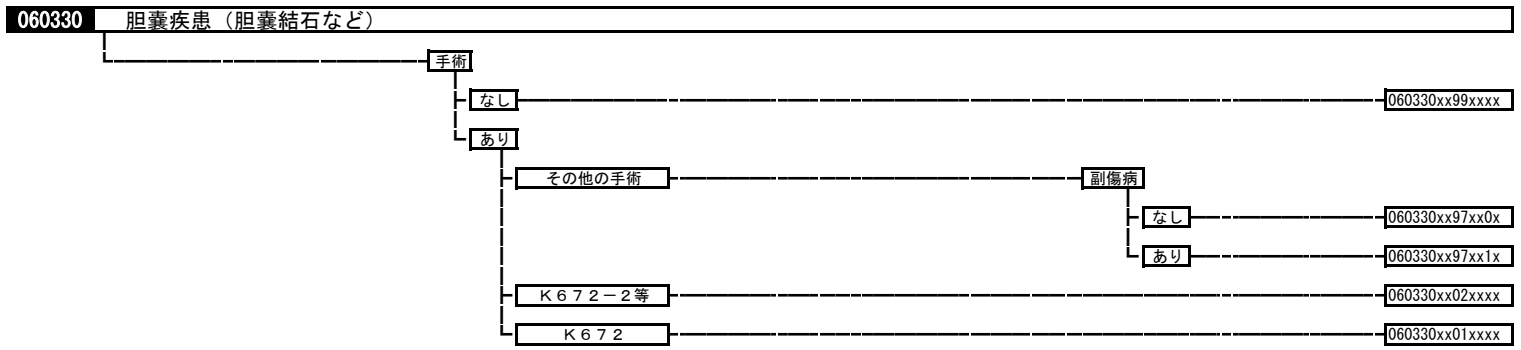

060340 胆管（肝内外）結石、胆管炎

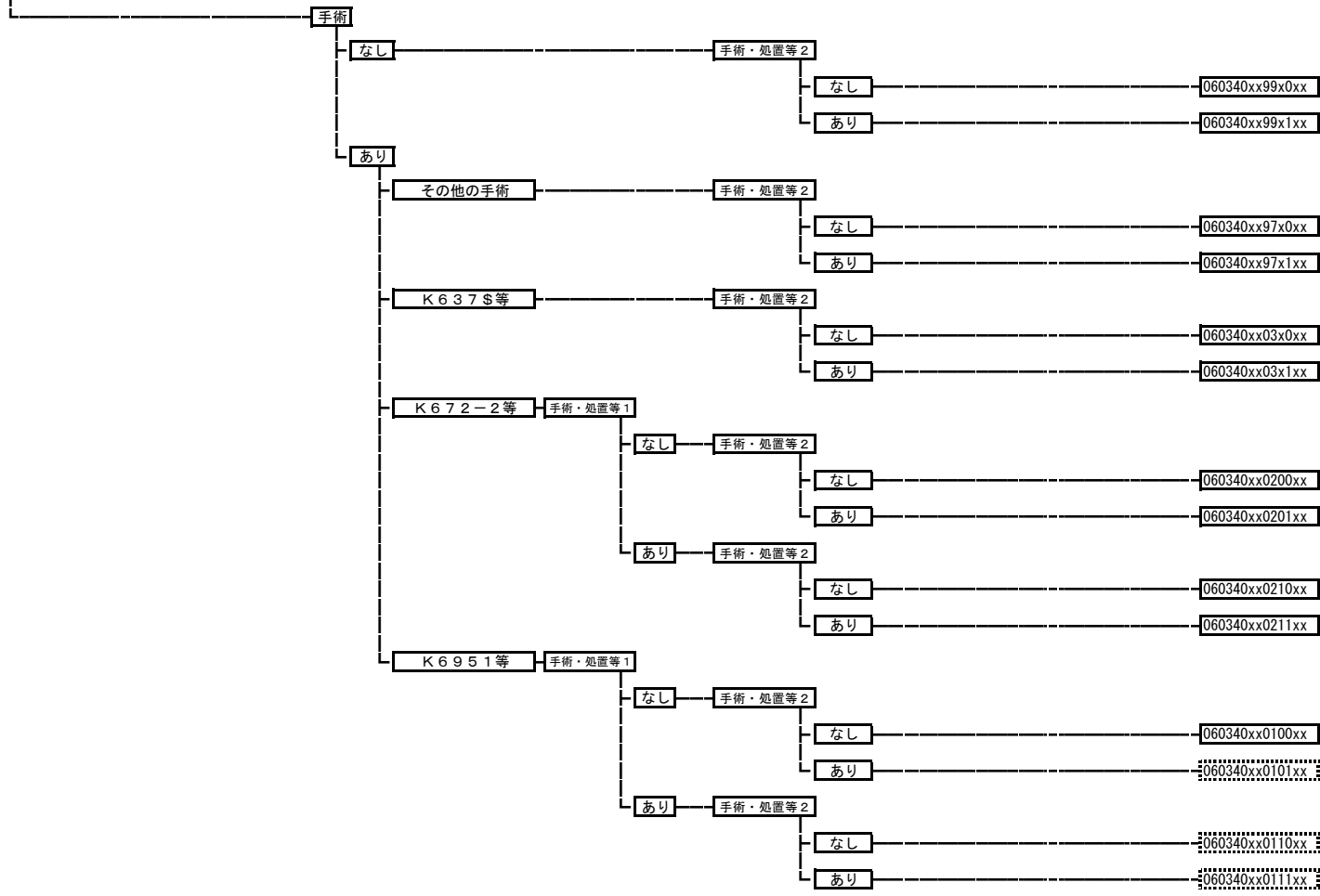

060350 急性膵炎

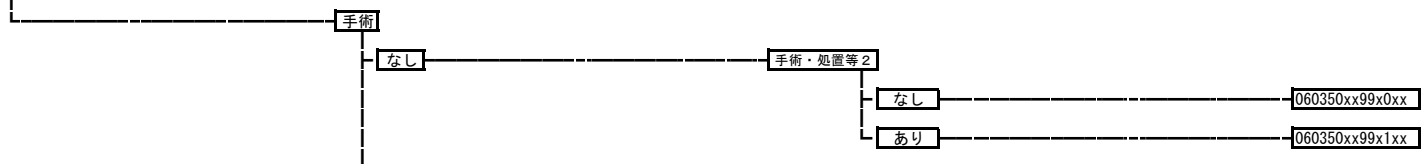

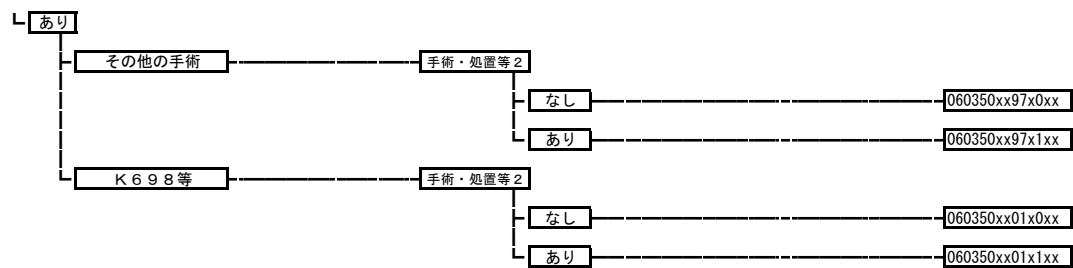

060360 慢性膵炎（膵嚢胞を含む。）

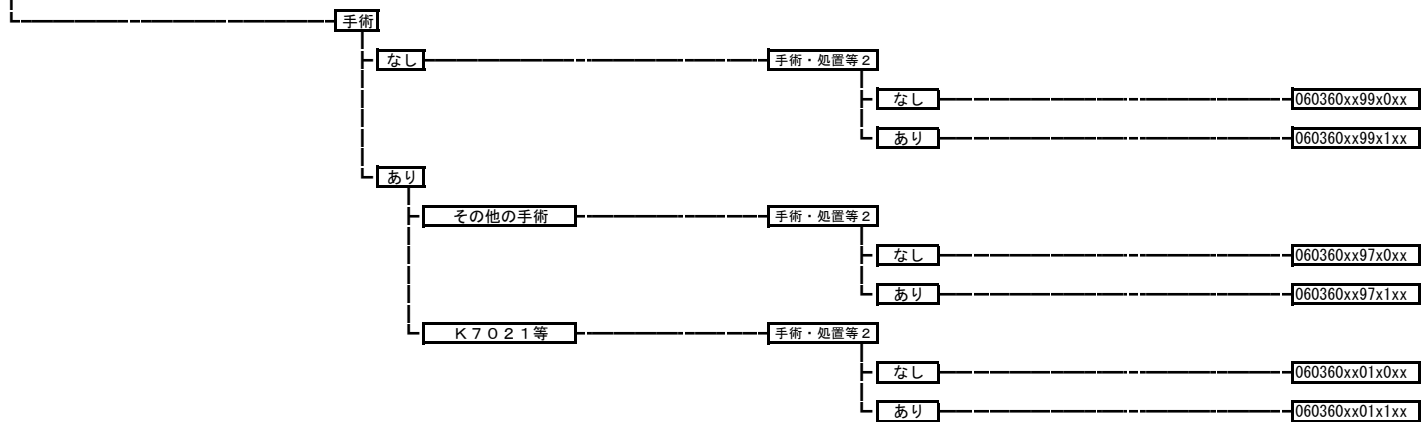

060370 腹膜炎、腹腔内膿瘍（女性器臓器を除く。）

