

**040210 気管支拡張症**

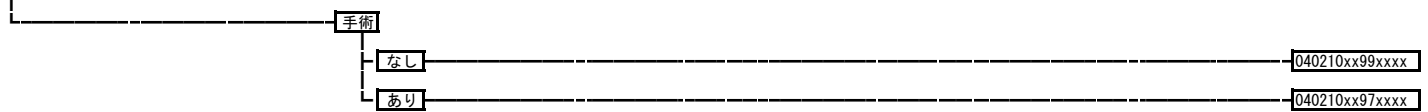

**040220 横隔膜腫瘍・横隔膜疾患（新生児を含む。）**

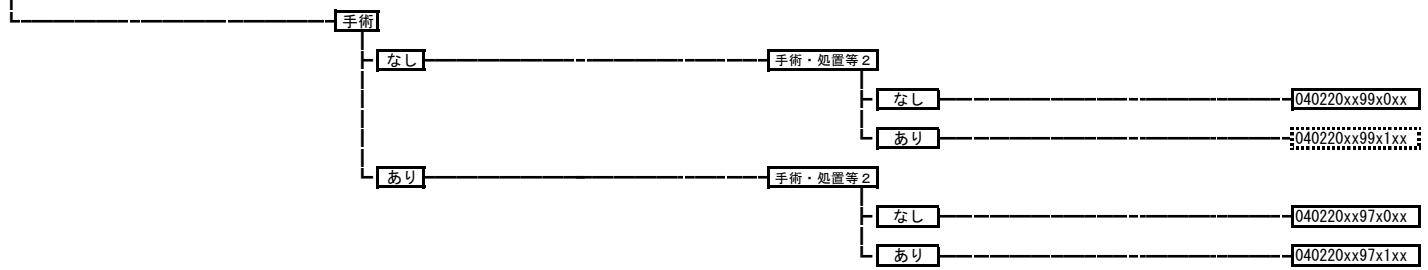

**040230 血胸、血気胸、乳び胸**

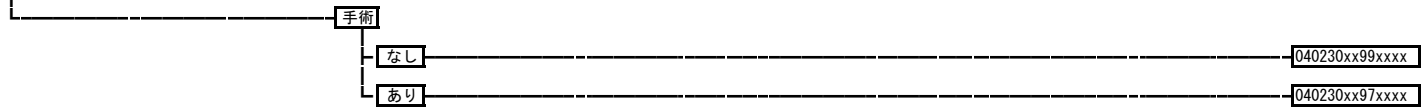

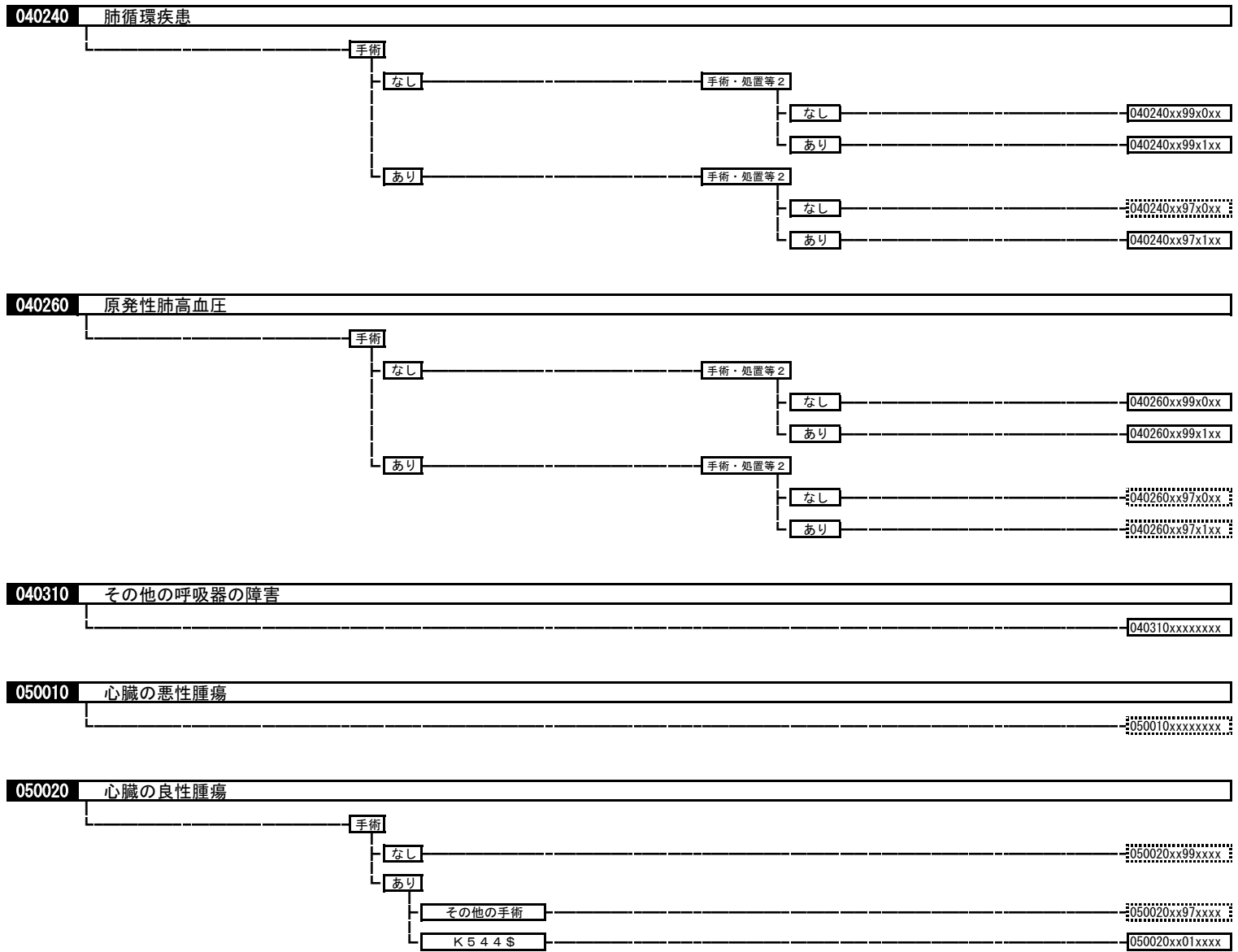

050030 急性心筋梗塞、再発性心筋梗塞

手術・処置等 2  
 1: 人工腎臓  
 2: SPECT、シンチグラム  
 3: tPA  
 4: 体外ペースメーカーなど

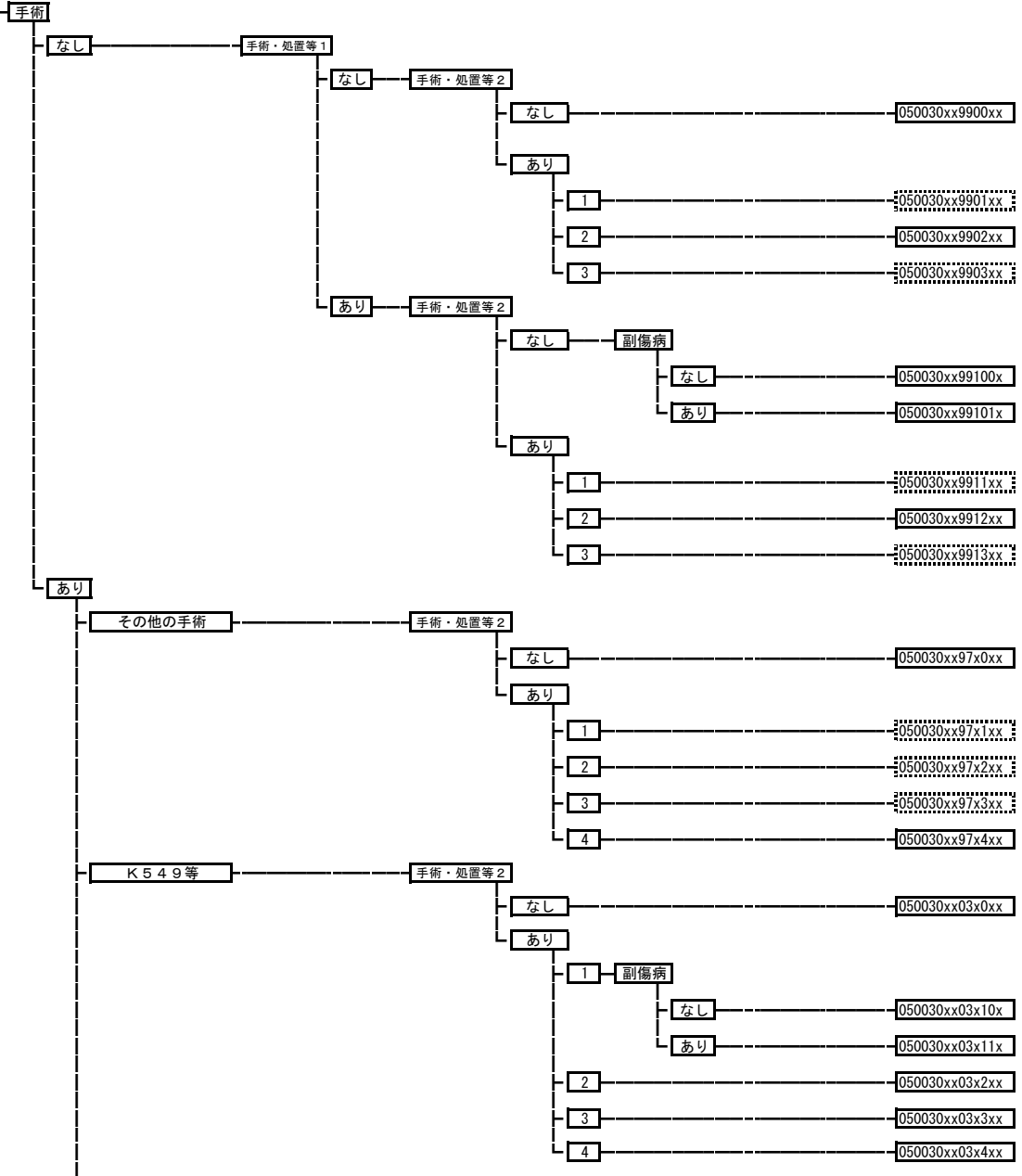

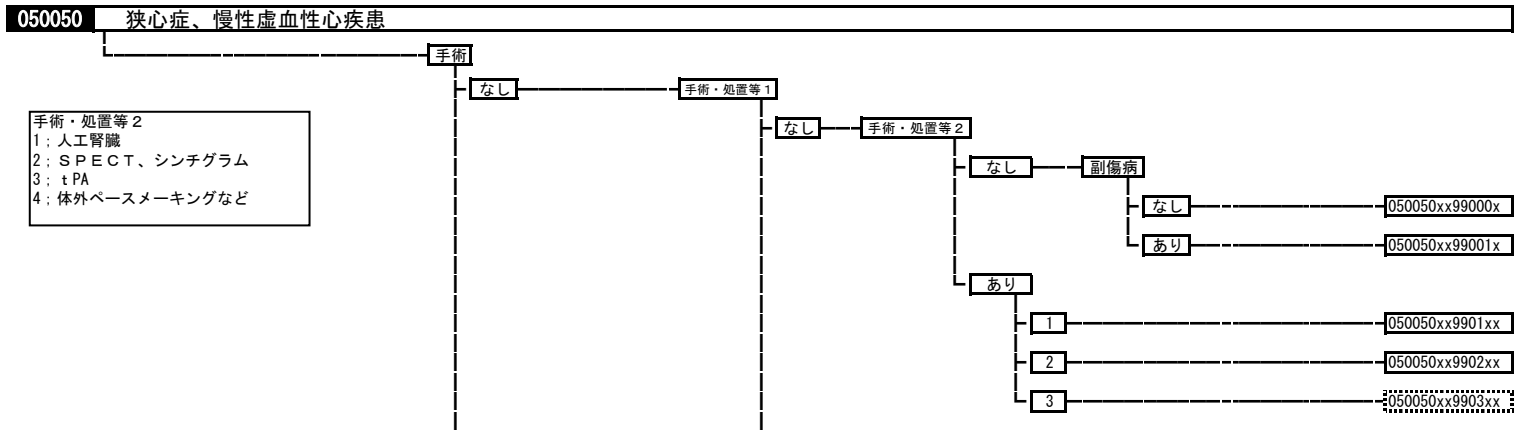
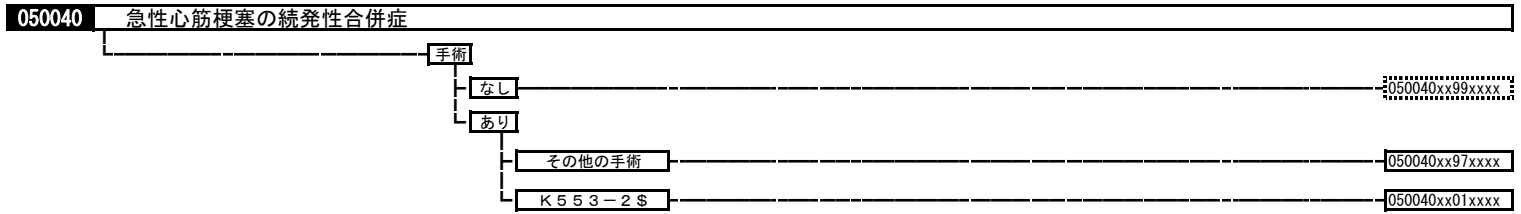
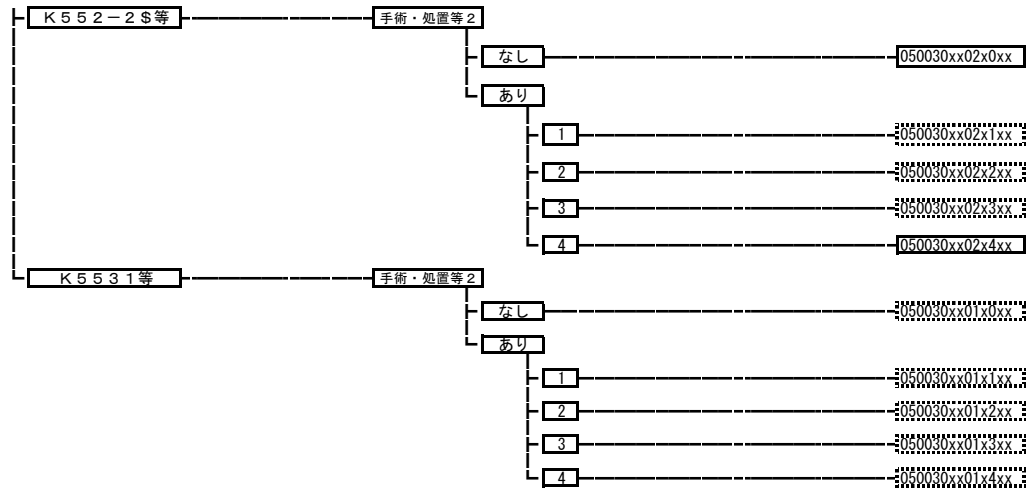

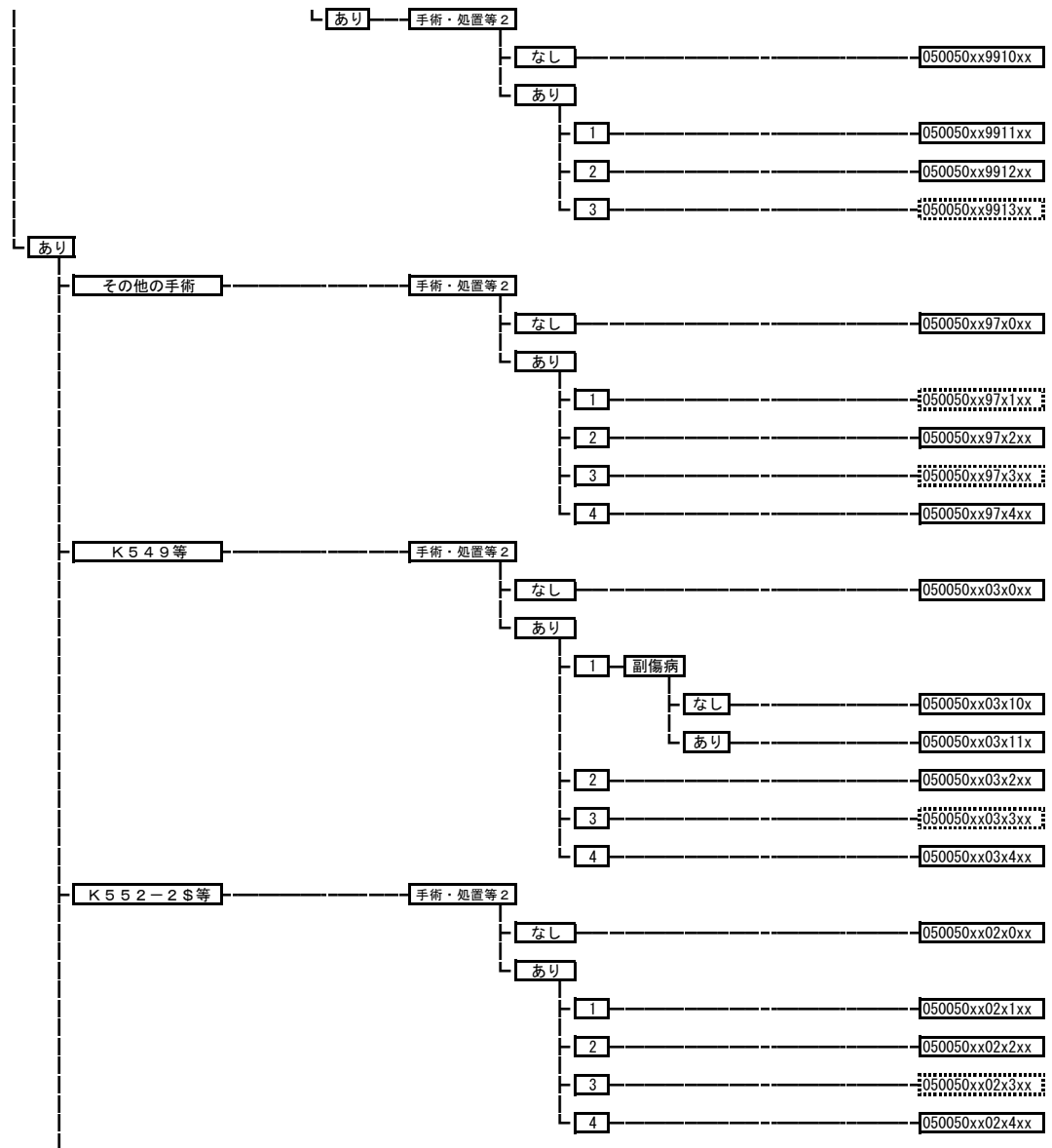

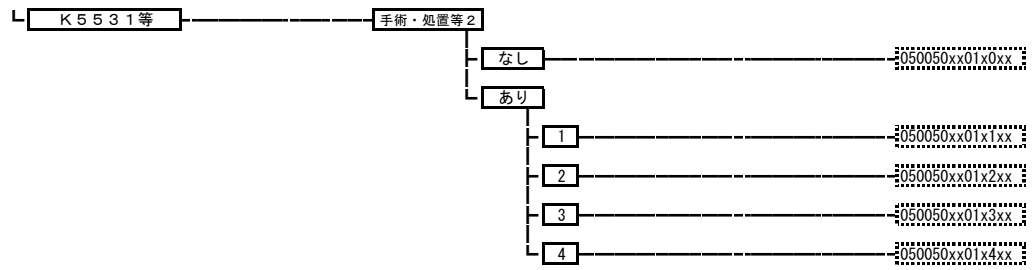

**050060 心筋症**

手術・処置等2  
 1: 人工腎臓  
 2: SPECT、シンチグラム  
 4: 体外ペースメーカーなど

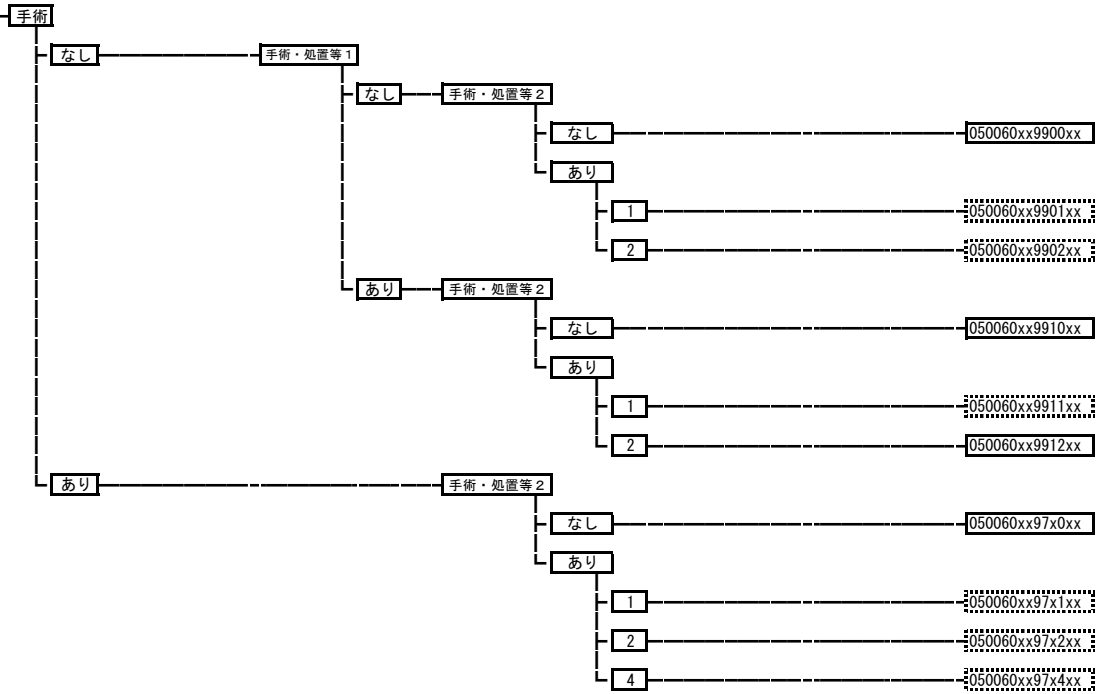

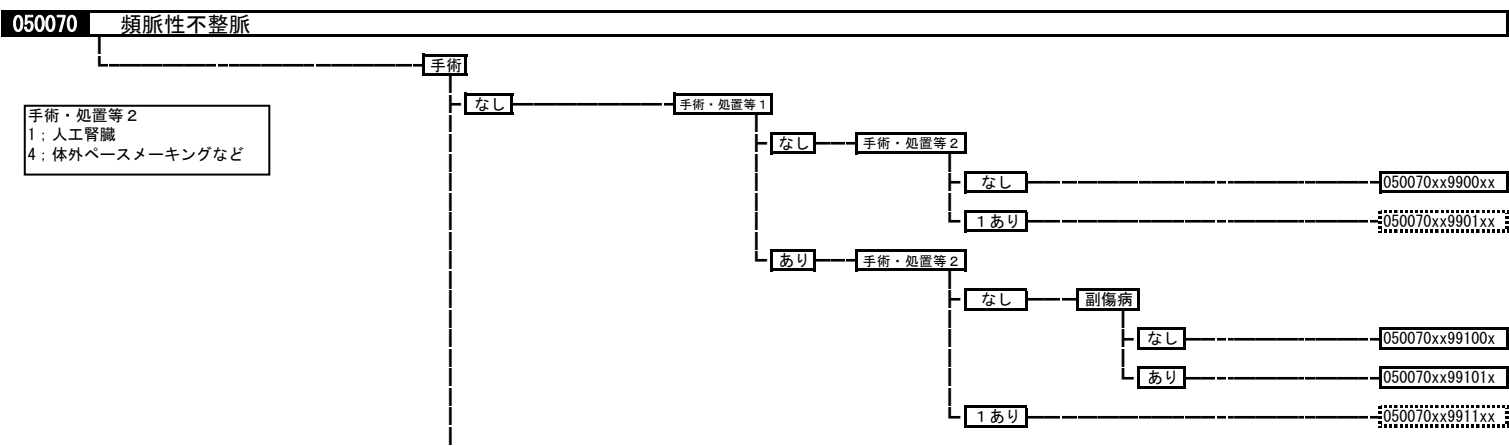
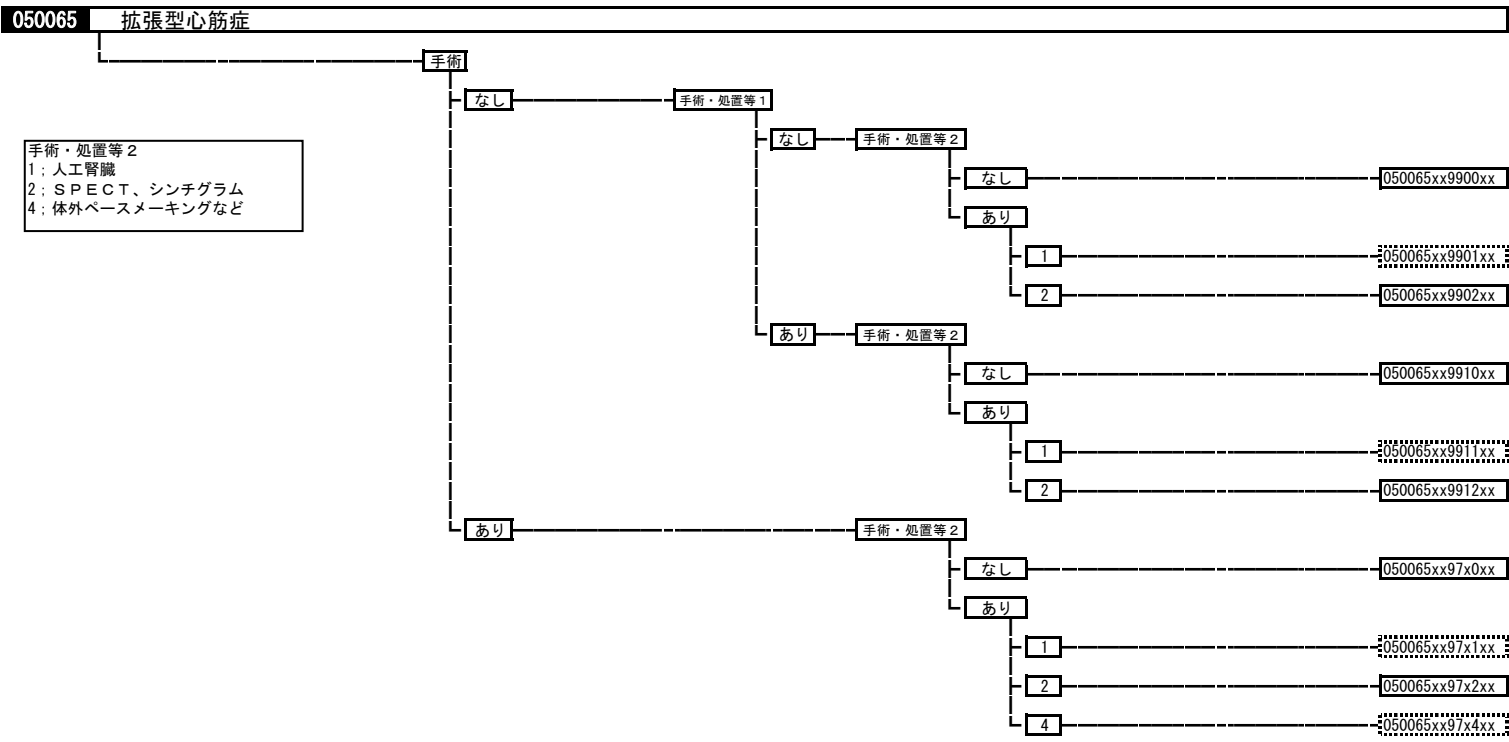



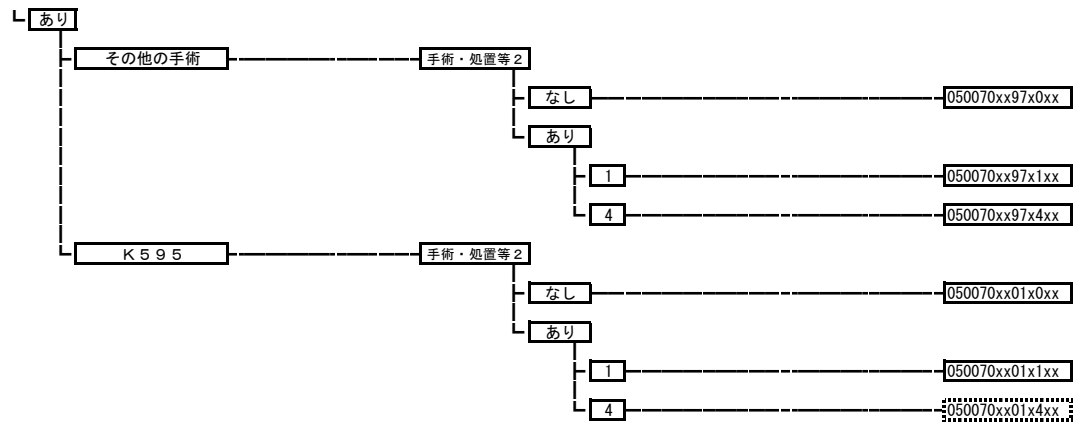

**050080 弁膜症**

手術・処置等2  
1: 人工腎臓  
4: 体外ペースメーカーなど

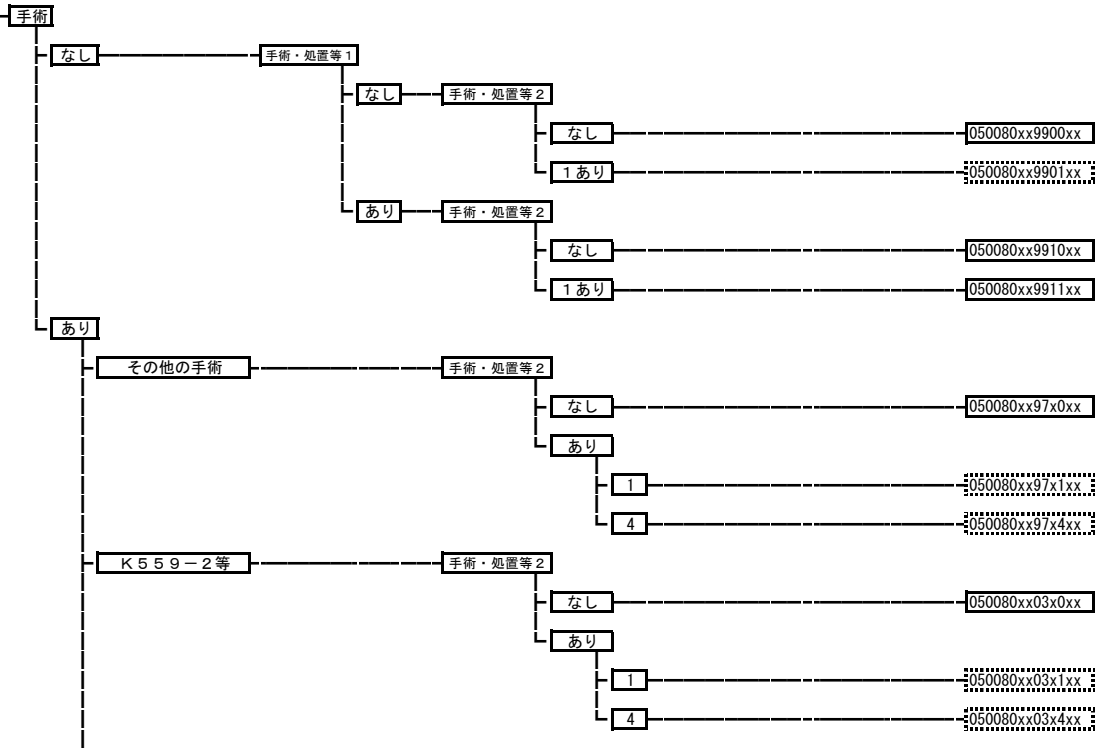

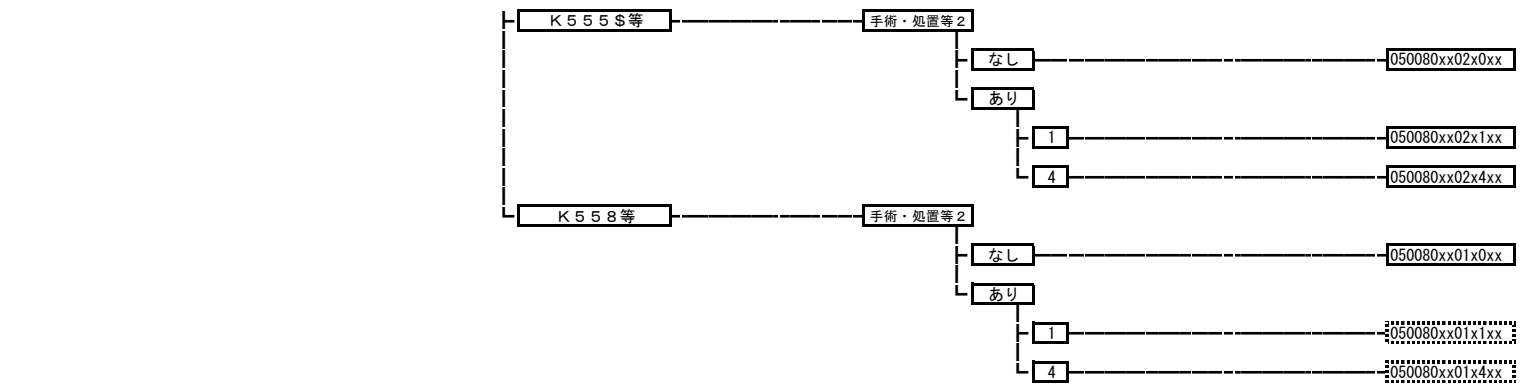

**050085 連合弁膜症**

手術・処置等 2  
1: 人工腎臓  
4: 体外ペースメーカーなど

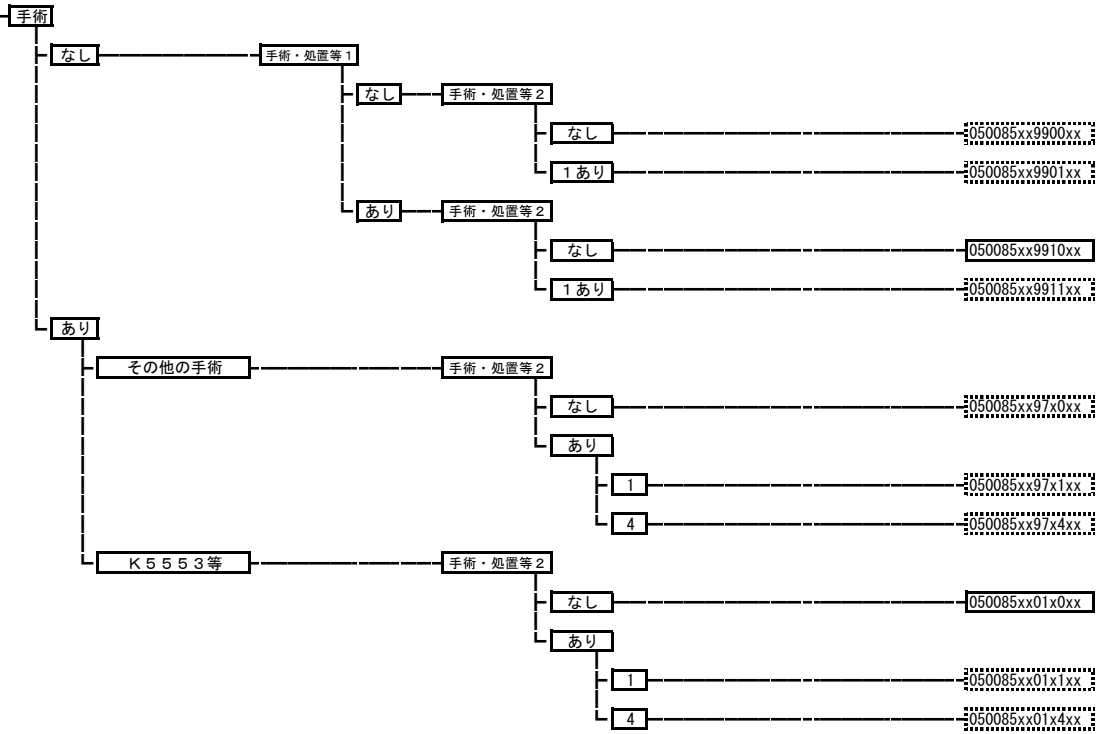

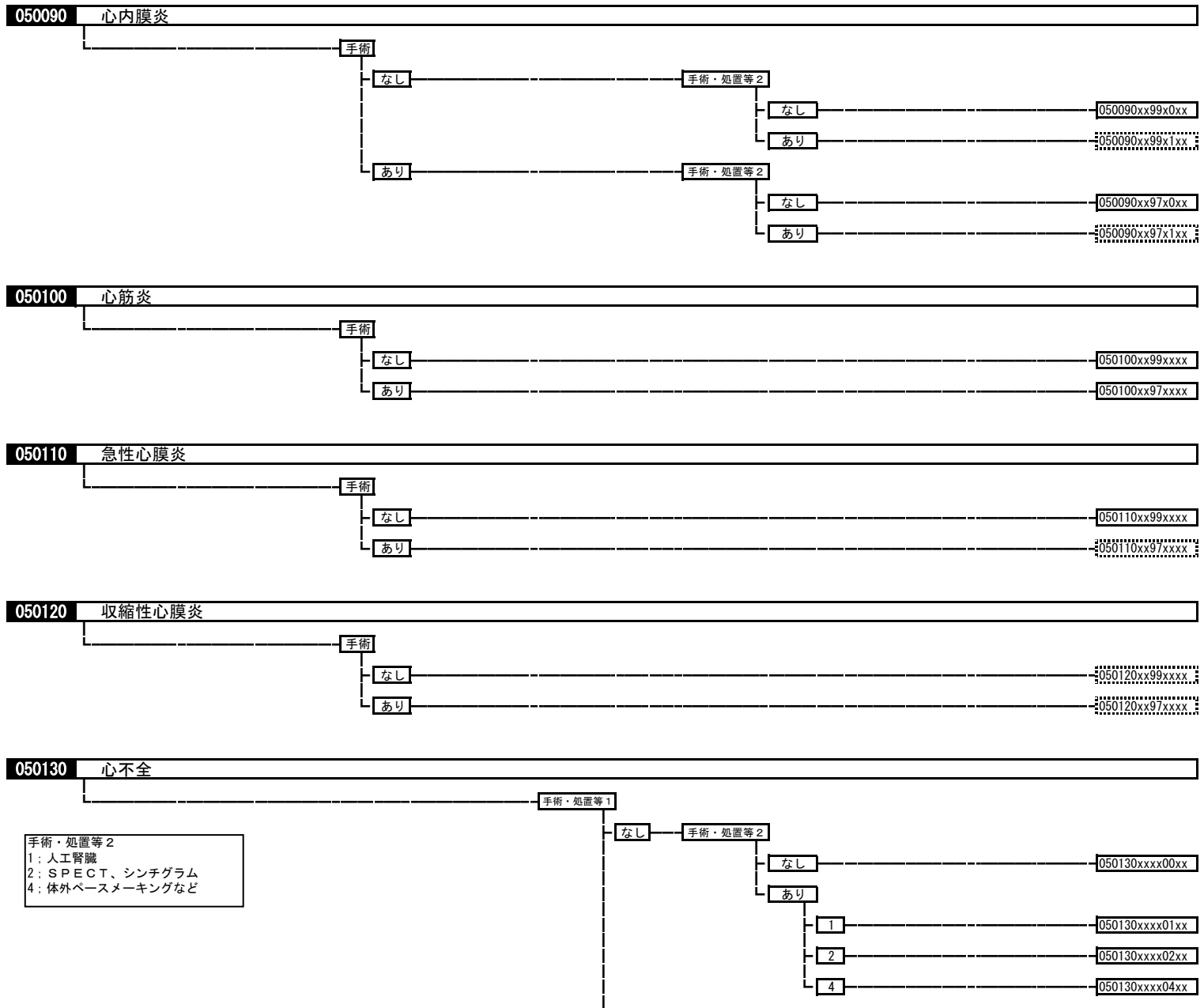

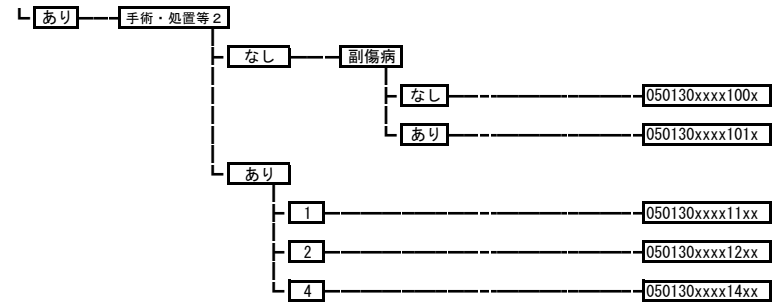

**050140 高血圧性疾患**

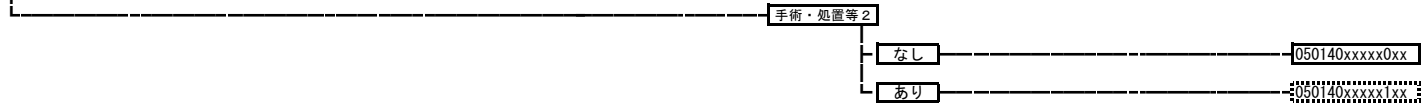

**050161 解離性大動脈瘤**

手術・処置等 2  
1: 人工腎臓  
4: 体外ペースメーカーなど

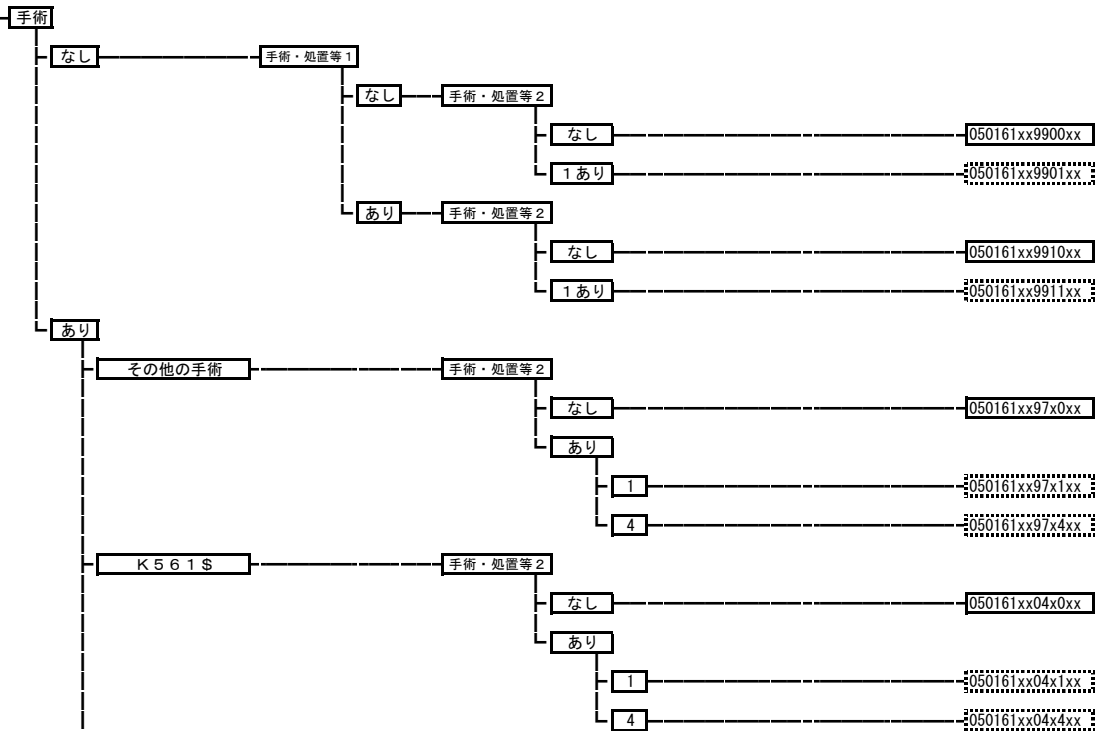

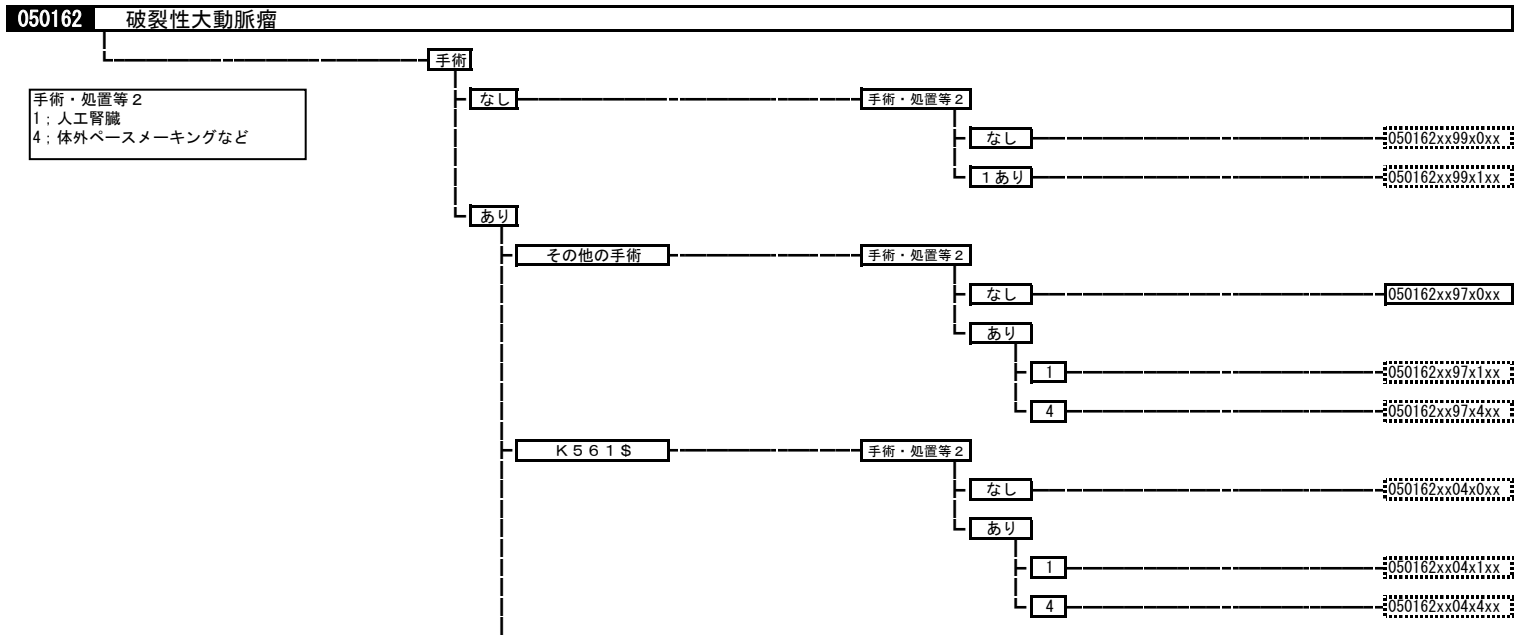
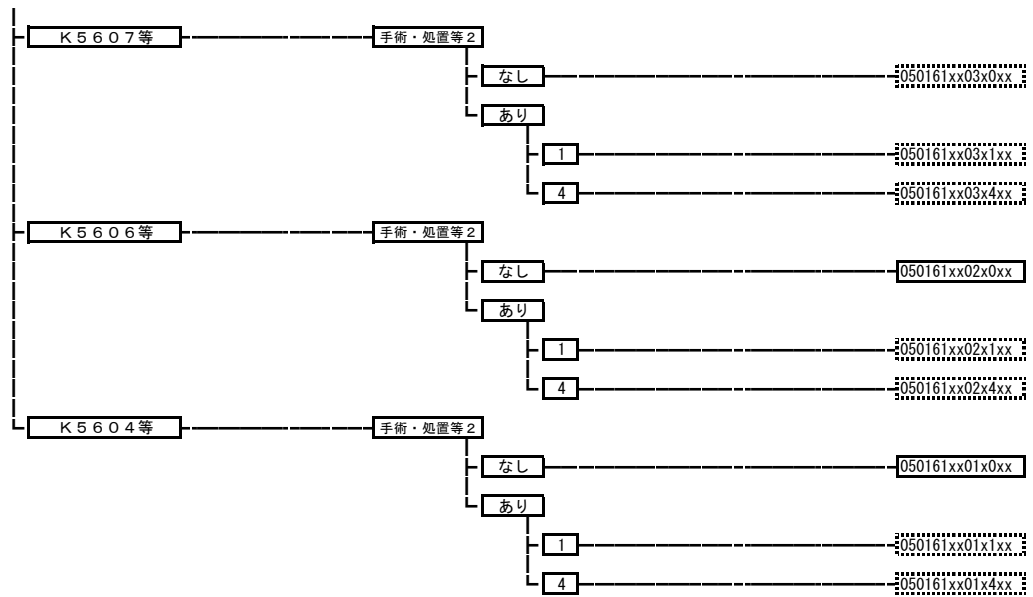

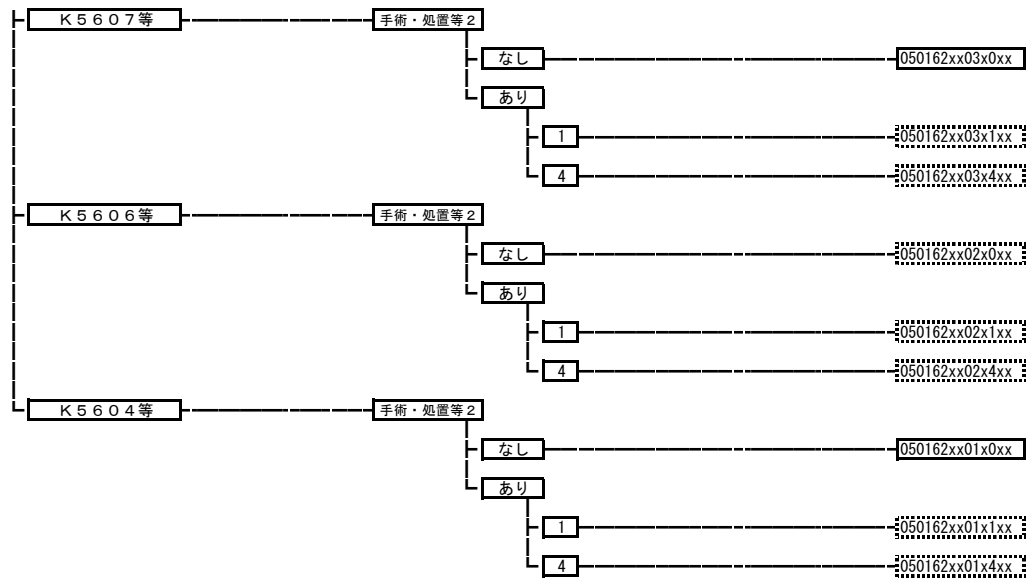

**050163 非破裂性大動脈瘤、腸骨動脈瘤**

手術・処置等2  
1; 人工腎臓  
4; 体外ペースメーカーなど

