

03001x	頭頸部悪性腫瘍					
	030010	口腔・下顎、口唇の悪性腫瘍	030014	下咽頭の悪性腫瘍	030018	聴器の悪性腫瘍
	030011	唾液腺の悪性腫瘍	030015	喉頭の悪性腫瘍	030019	頭頸部悪性腫瘍（その他）
	030012	上咽頭の悪性腫瘍	030016	鼻腔・副鼻腔の悪性腫瘍		
	030013	中咽頭の悪性腫瘍	030017	転移性頭部悪性腫瘍		

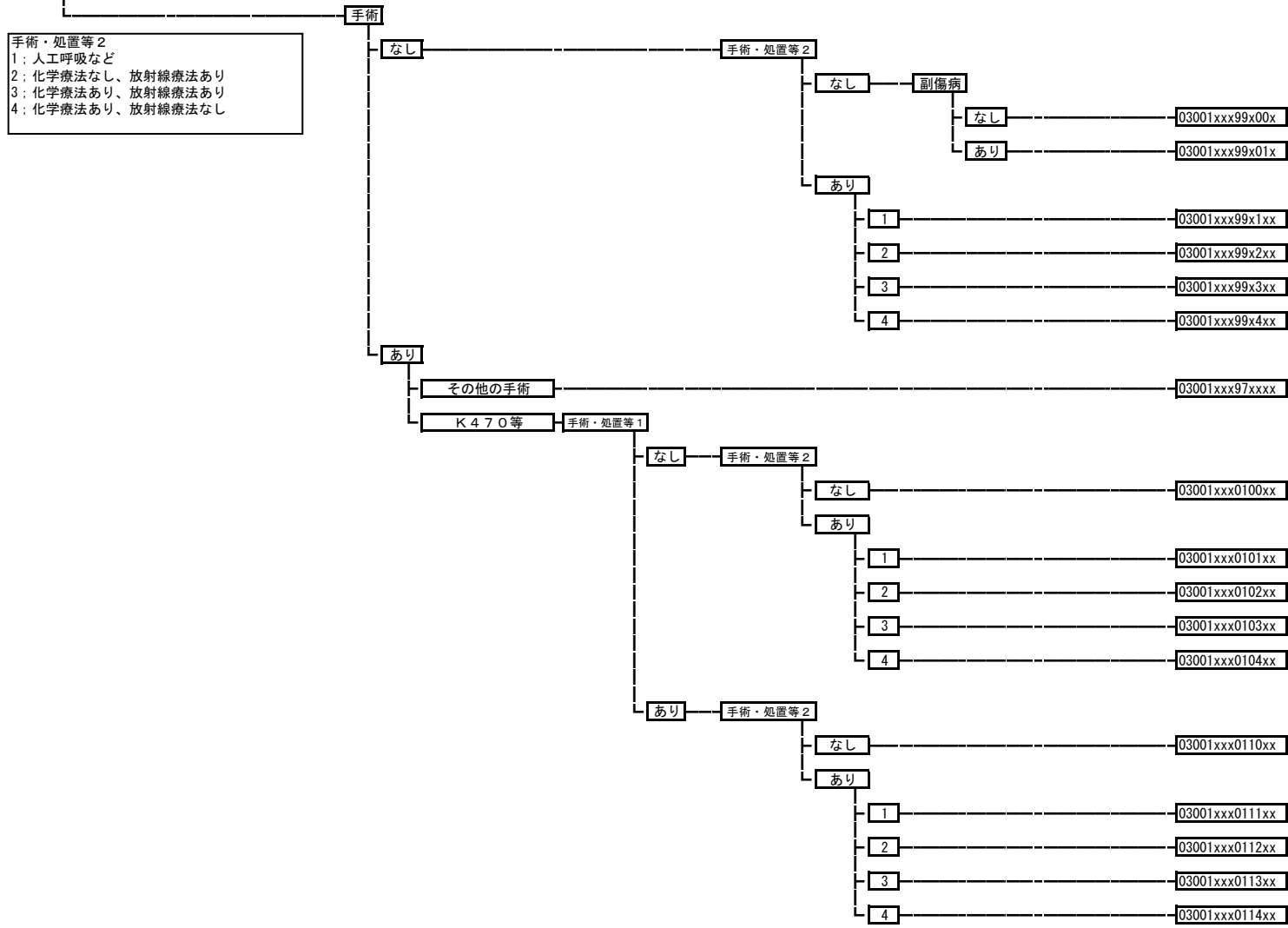

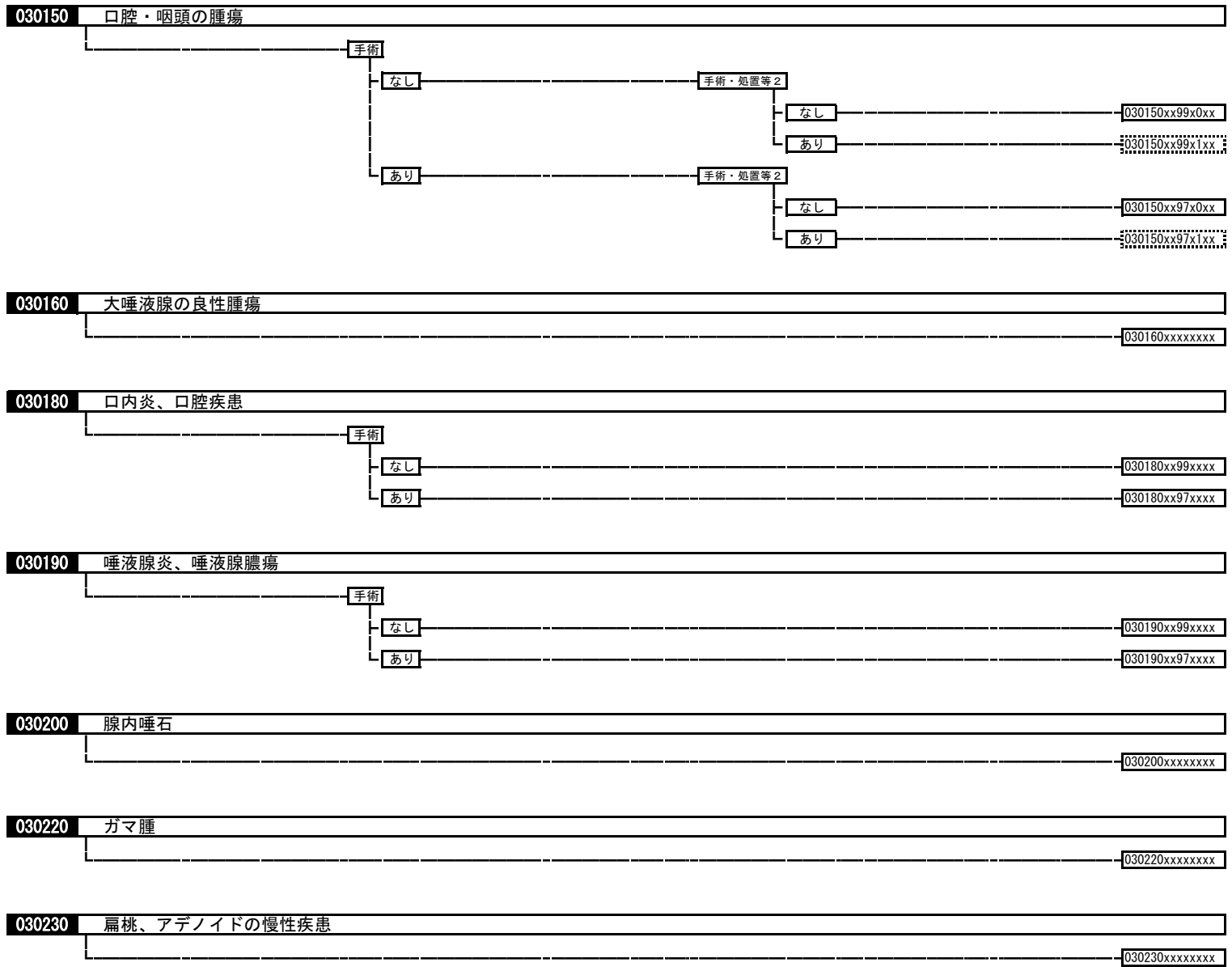

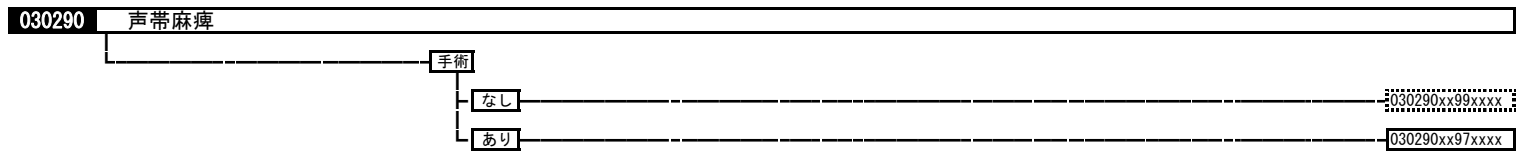
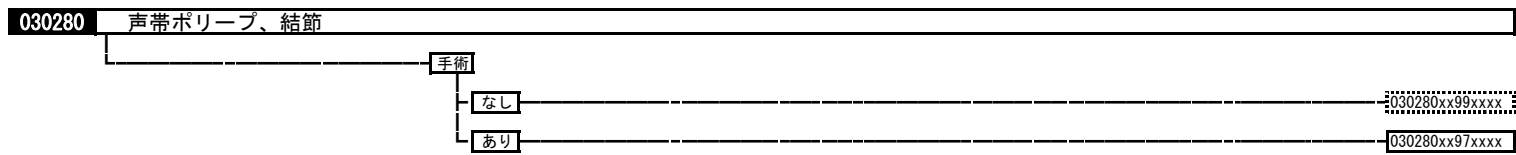
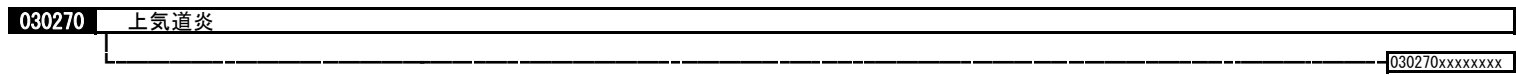
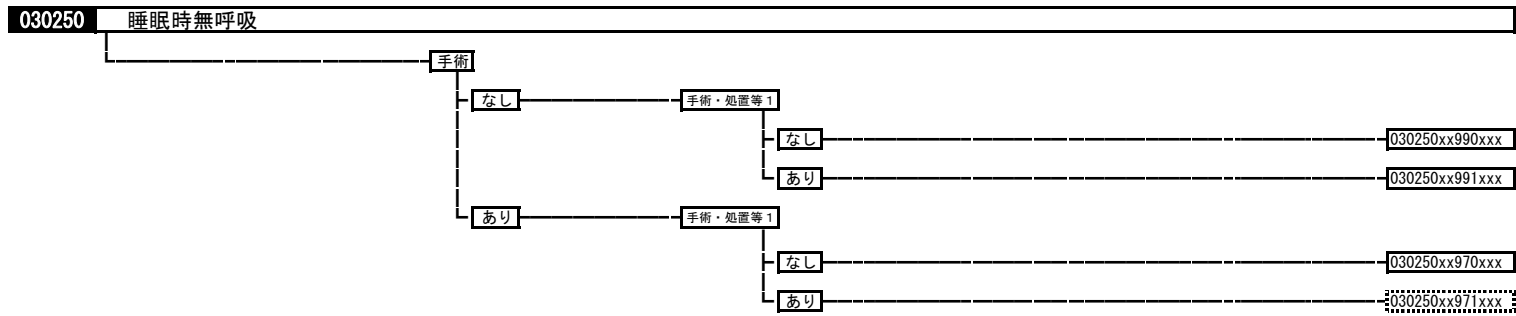
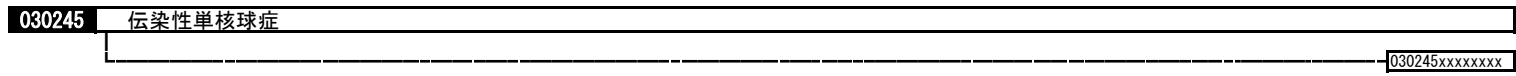
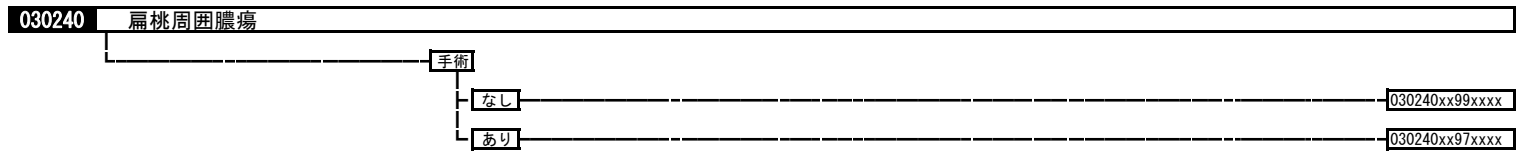

030300	声帯の疾患（その他）	
	手術	
	なし	030300xx99xxxx
	あり	
	その他の手術	030300xx97xxxx
	K389S等	030300xx01xxxx
030320	鼻中隔彎曲症	030320xxxxxxxx
030330	急性副鼻腔炎	
	手術	
	なし	030330xx99xxxx
	あり	030330xx97xxxx
030340	血管運動性鼻炎、アレルギー性鼻炎<鼻アレルギー>	030340xxxxxxxx
030350	慢性副鼻腔炎	030350xxxxxxxx
030360	副鼻腔嚢胞、鼻前庭嚢胞	030360xxxxxxxx
030370	鼻ポリープ	030370xxxxxxxx
030380	鼻出血	030380xxxxxxxx

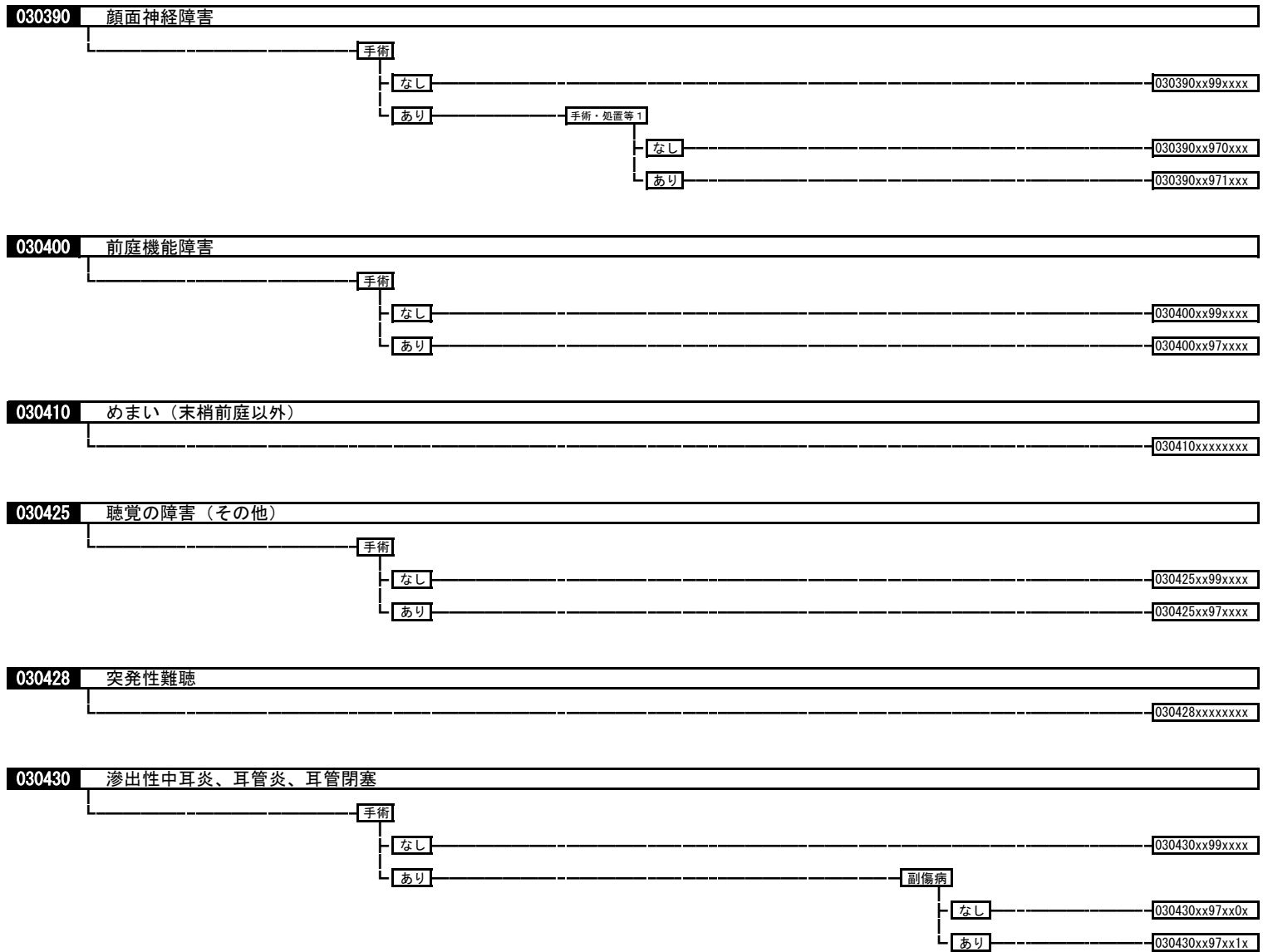

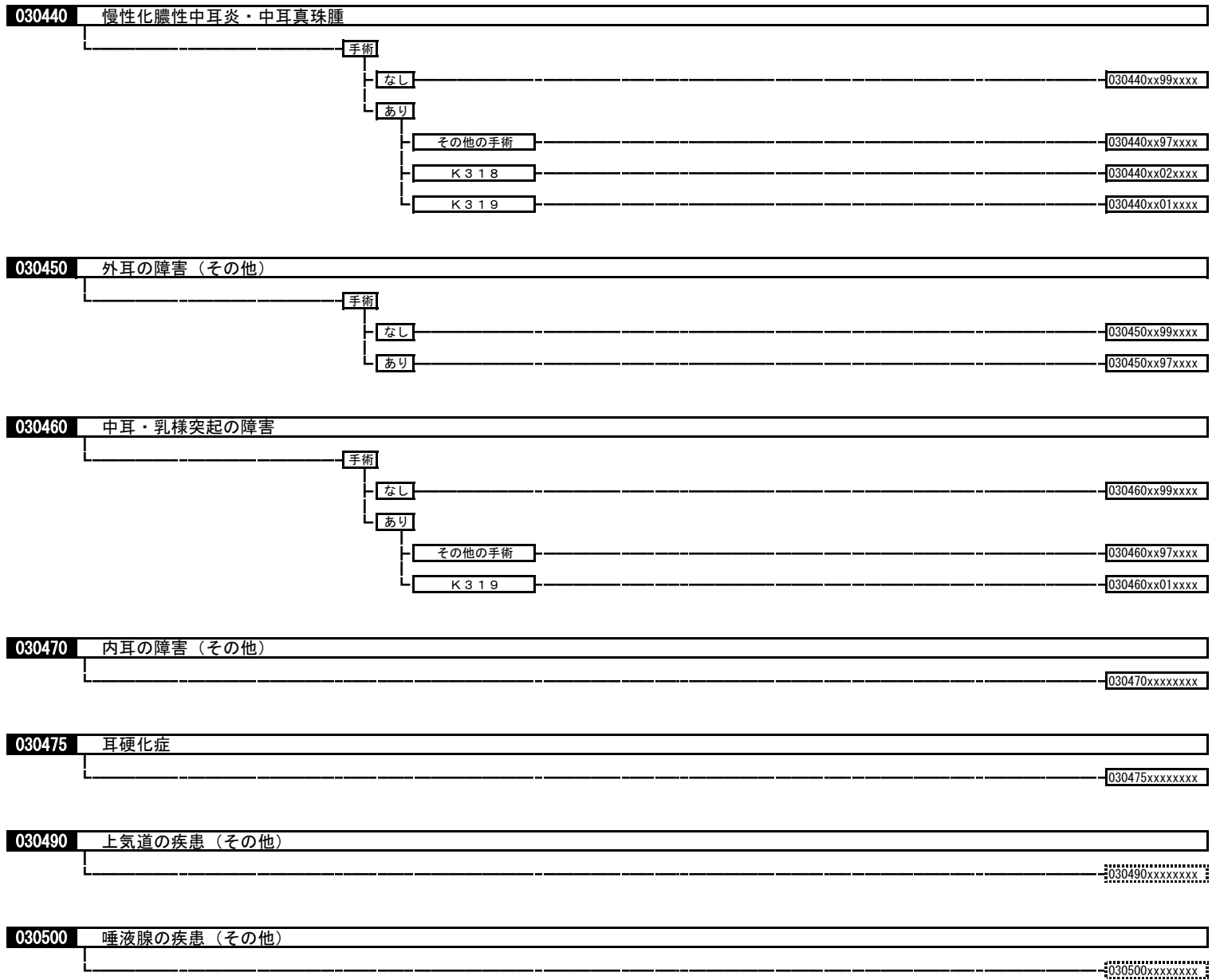

040010 縦隔悪性腫瘍、縦隔・胸膜の悪性腫瘍

手術・処置等 2
 1: 人工呼吸など
 2: 放射線療法
 3: 化学療法あり、放射線療法なし

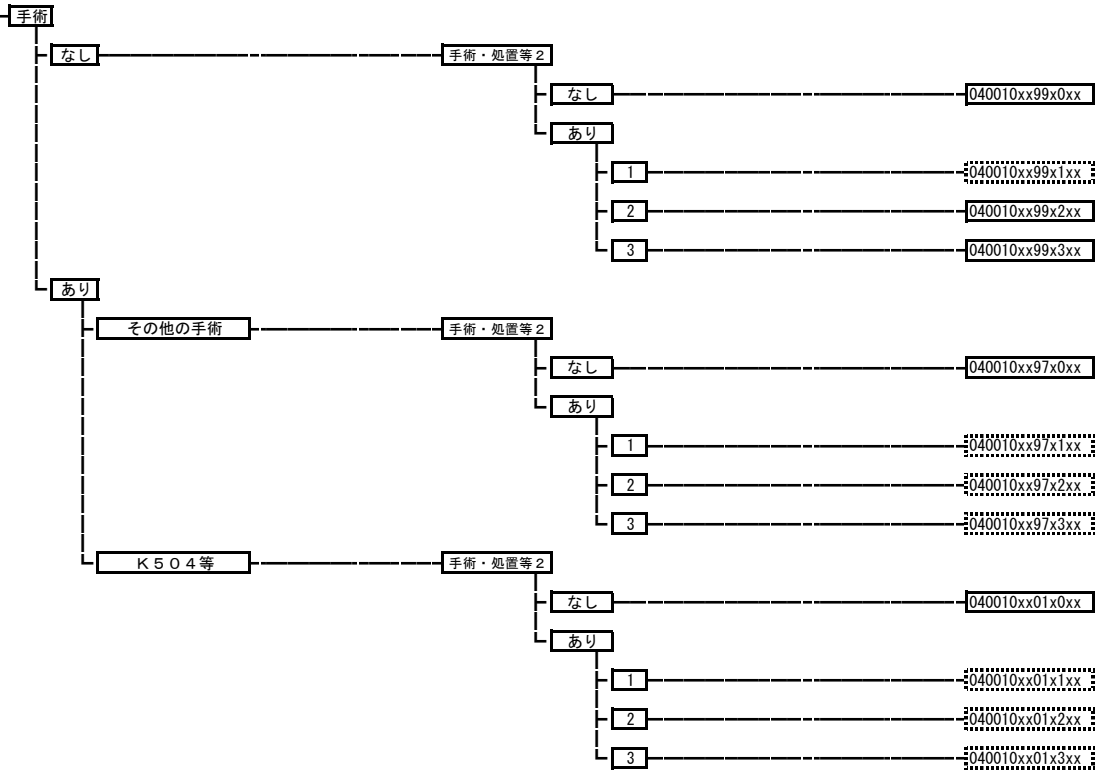

040020 縦隔の良性腫瘍

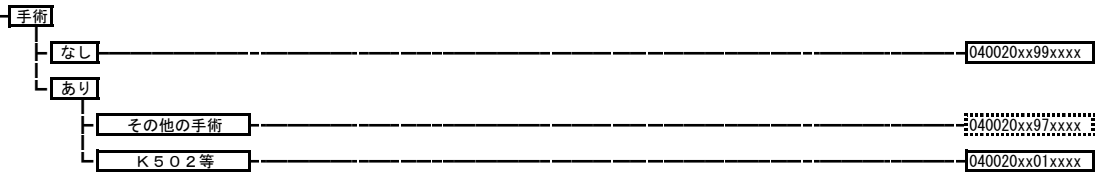

040030 呼吸器系の良性腫瘍

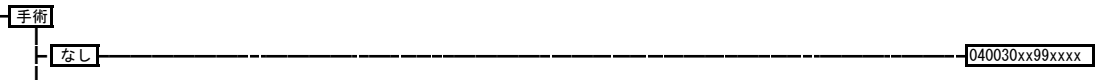

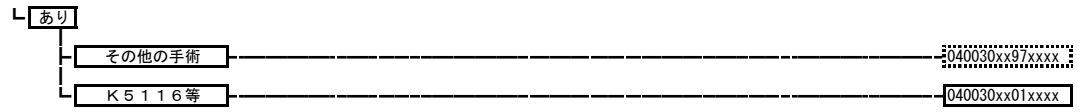

040040 肺の悪性腫瘍

手術・処置等 2
 1; 人工呼吸など
 2; 化学療法なし、放射線療法あり
 3; 化学療法あり、放射線療法あり
 4; 化学療法あり、放射線療法なし
 5; カルボプラチン+パクリタキセルあり

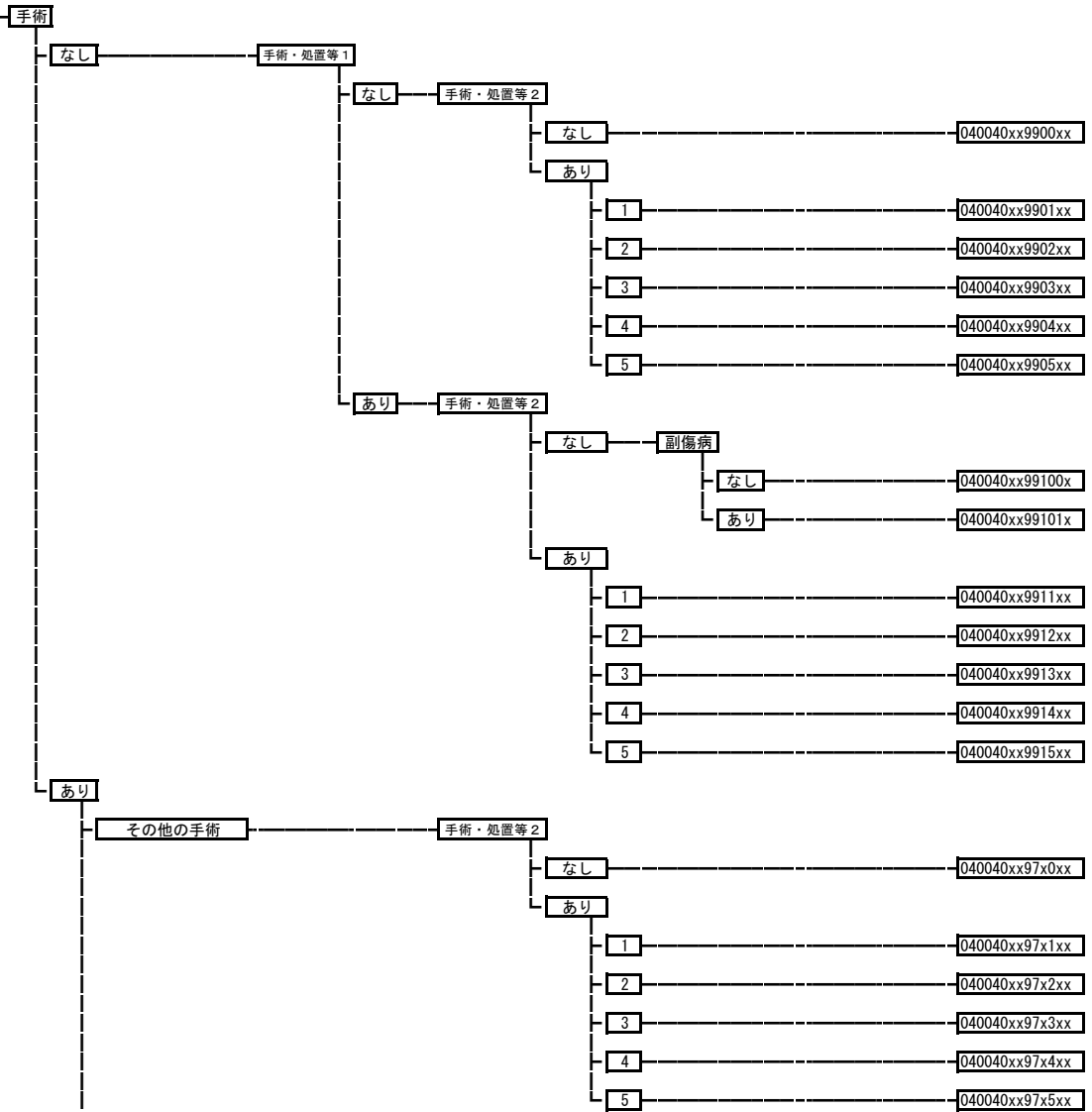

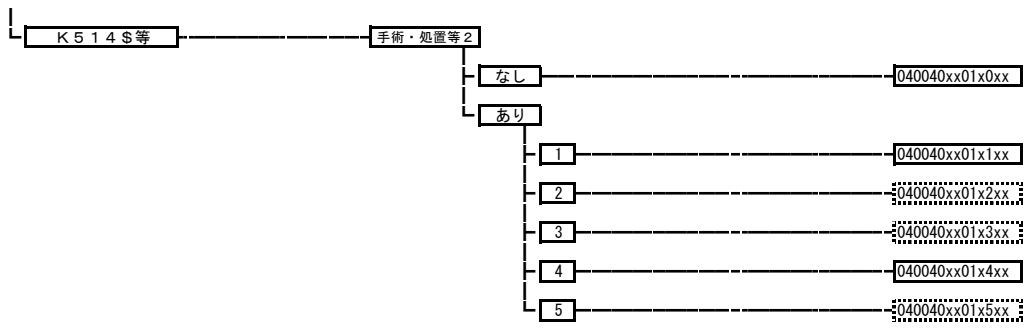

040050 胸壁腫瘍、胸膜腫瘍

手術・処置等2
 1: 人工呼吸など
 2: 放射線療法
 3: 化学療法あり、放射線療法なし
 4: ベメトレキセド

